



# CITY

60013











+



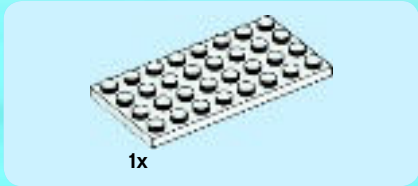

1

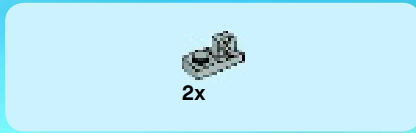

2



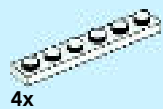

4x

**3**

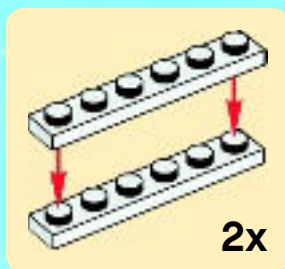
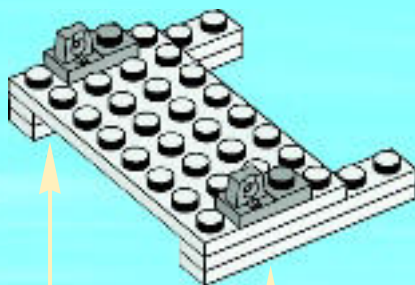

2x

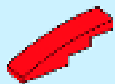

2x



1x

4

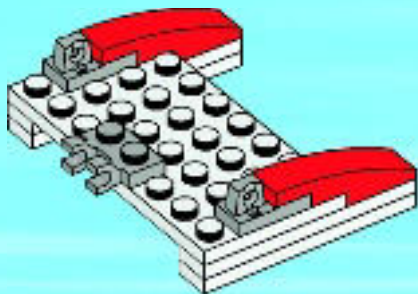

1x



1x

5

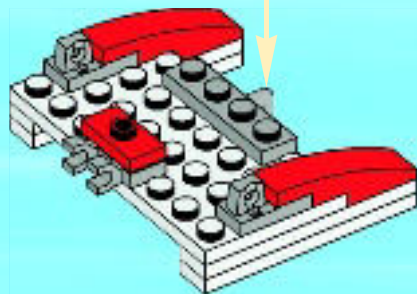
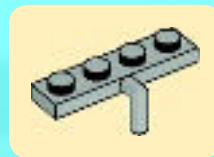



1x



1x

# 6

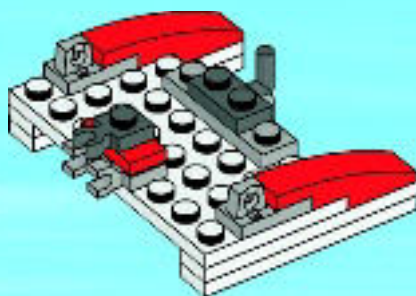





1x



1x

# 7

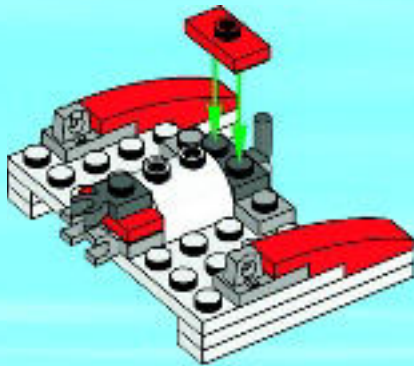

1x



1x

# 8

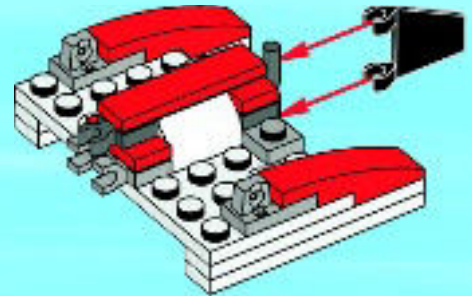



9

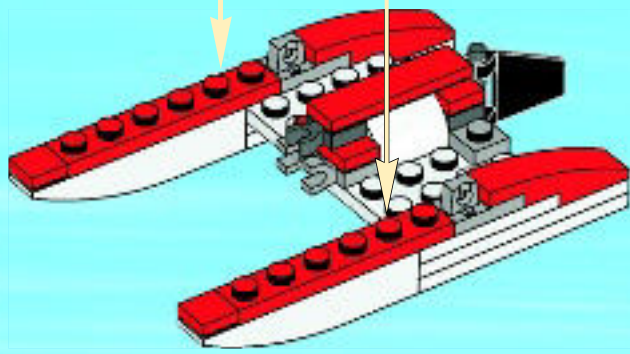
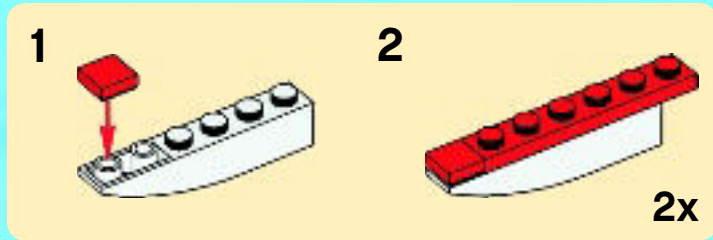



2x

# 10

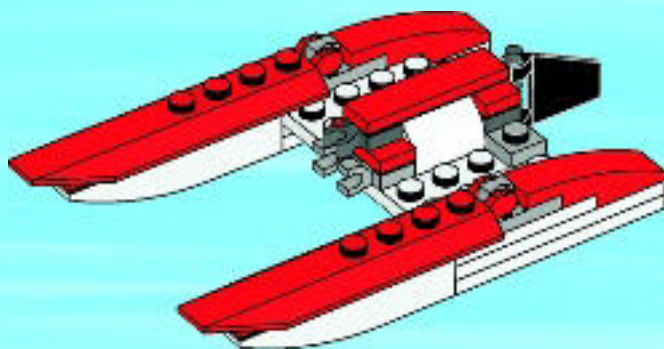



11

1



2



**3**



**4**





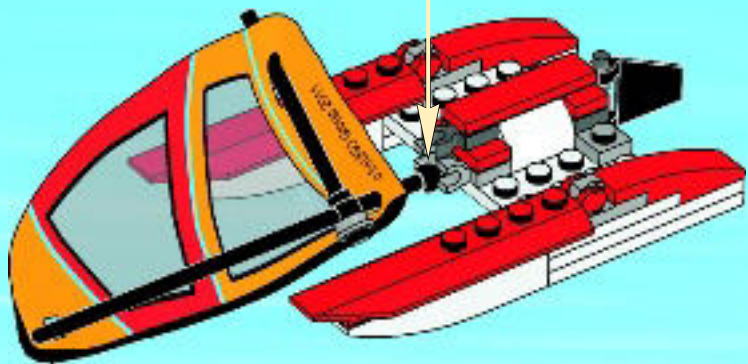

12

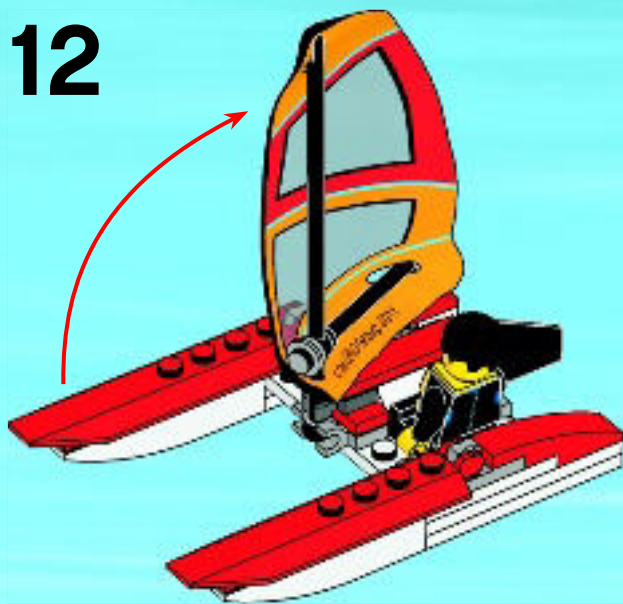

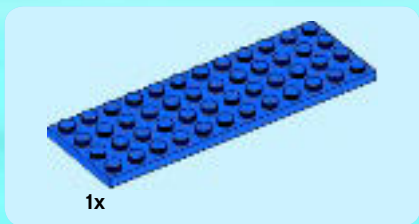

1x

1



2x

2

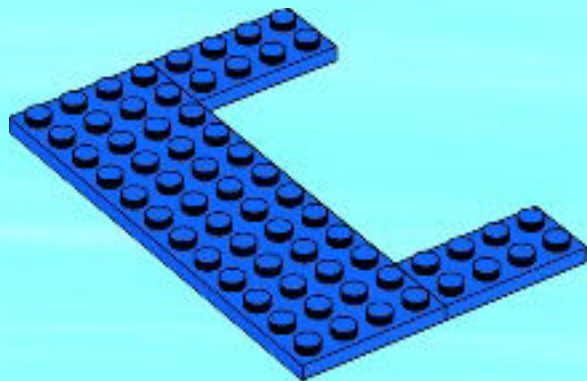



2x

3

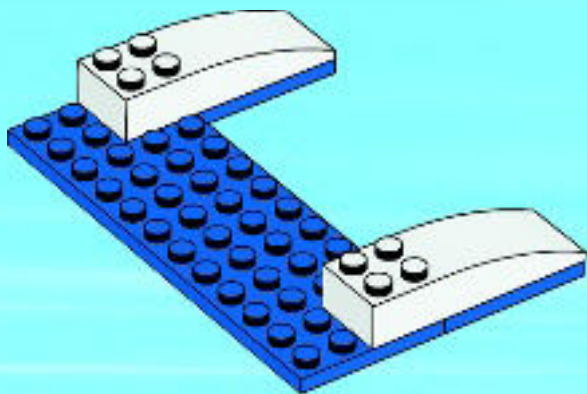

4x

4

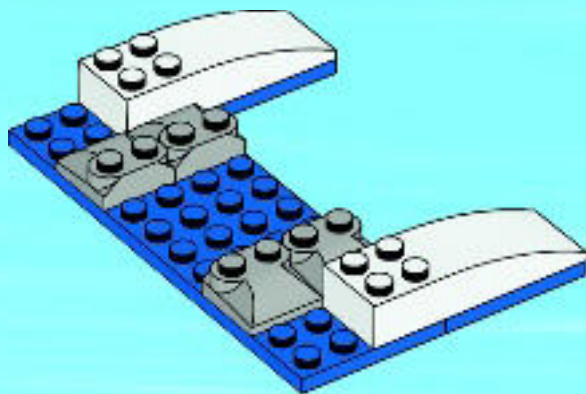

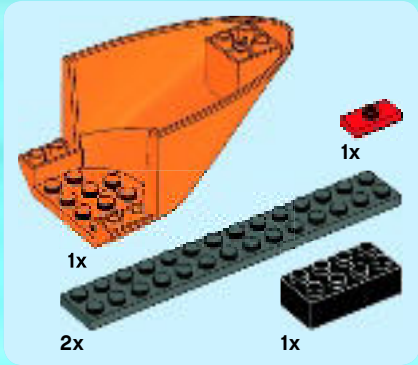
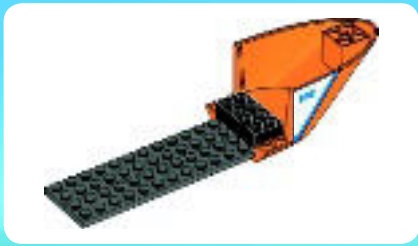

5

1

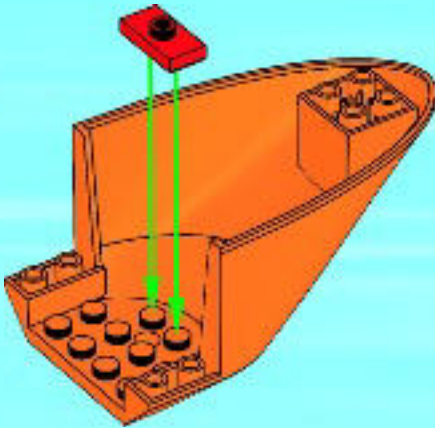

2

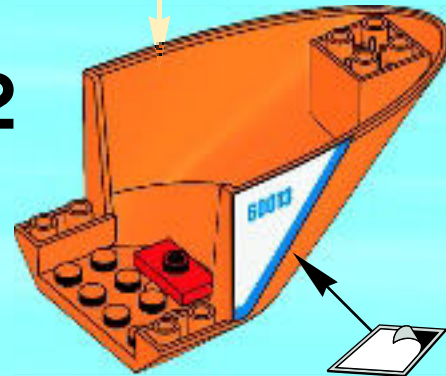

3

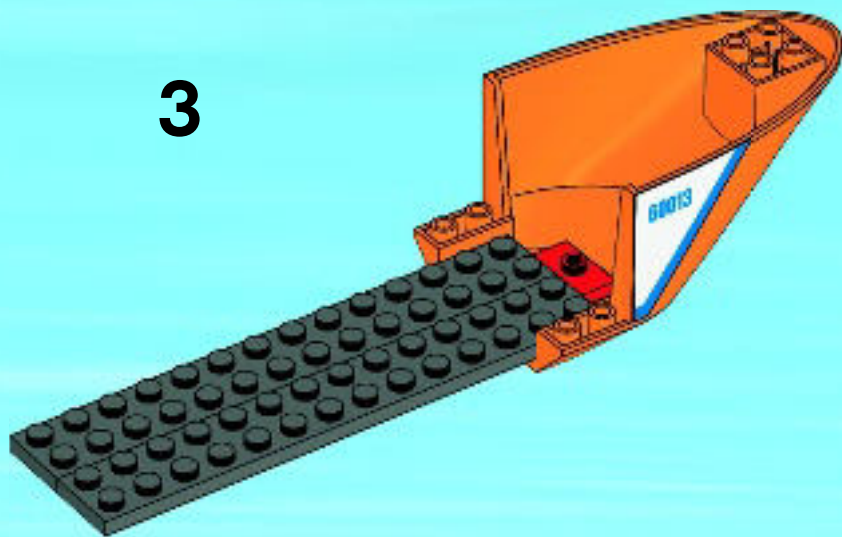



4

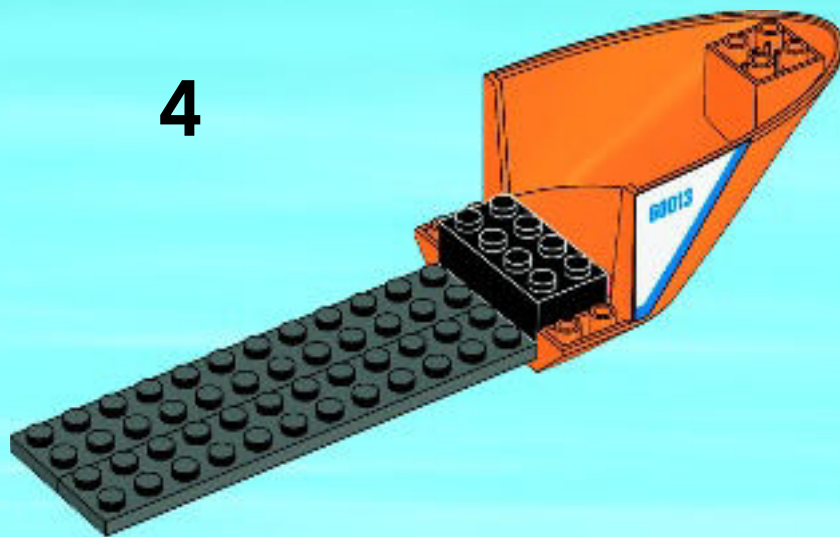

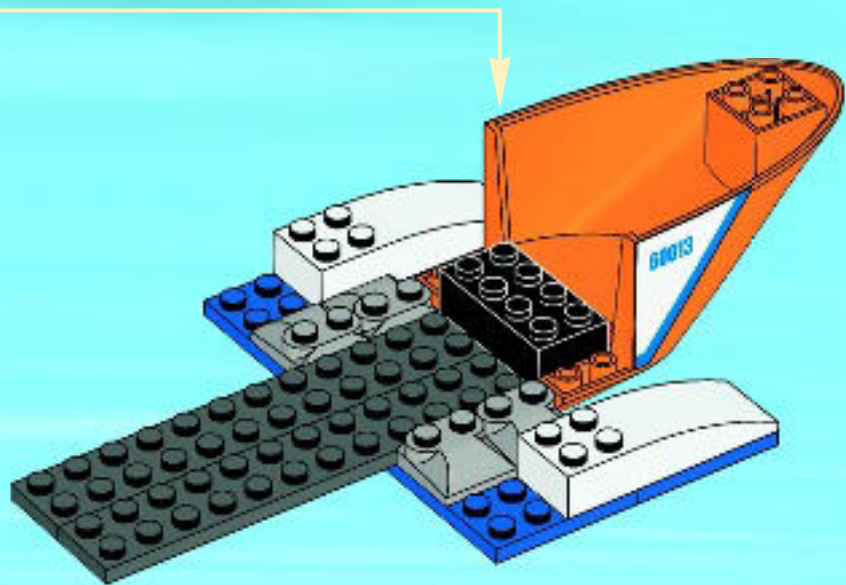



6

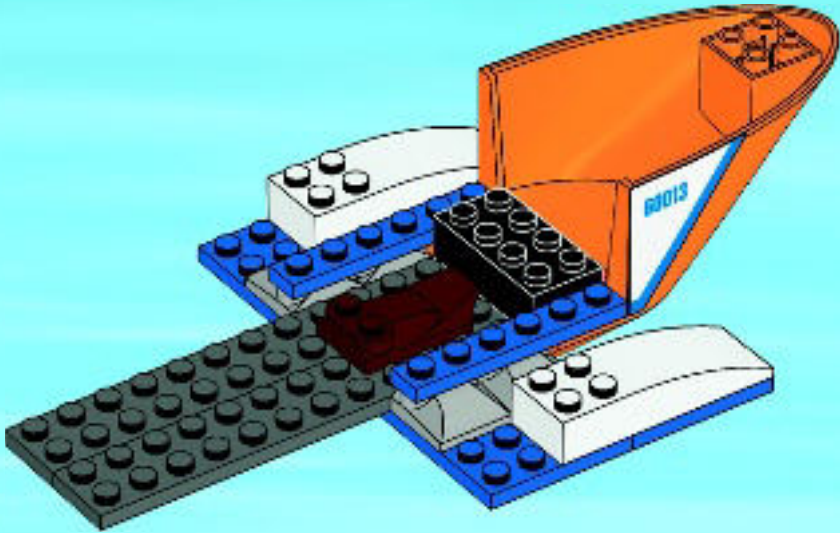





2x

8

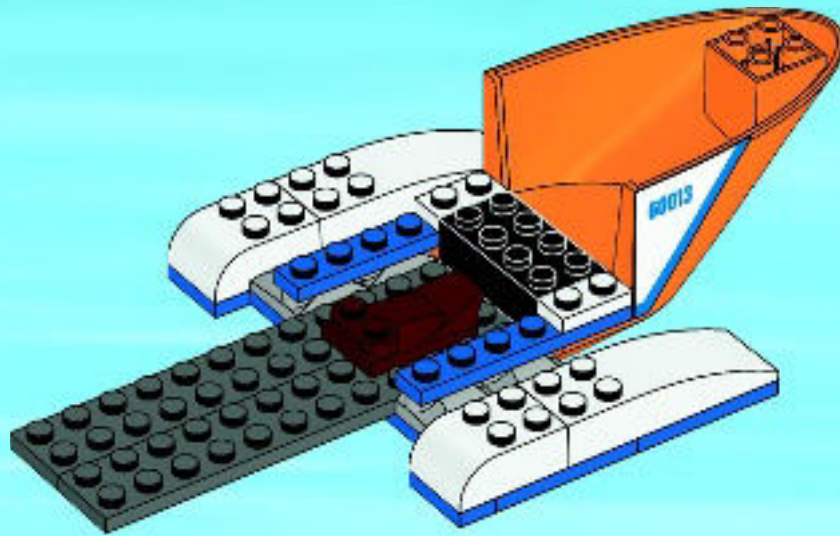





1x

9

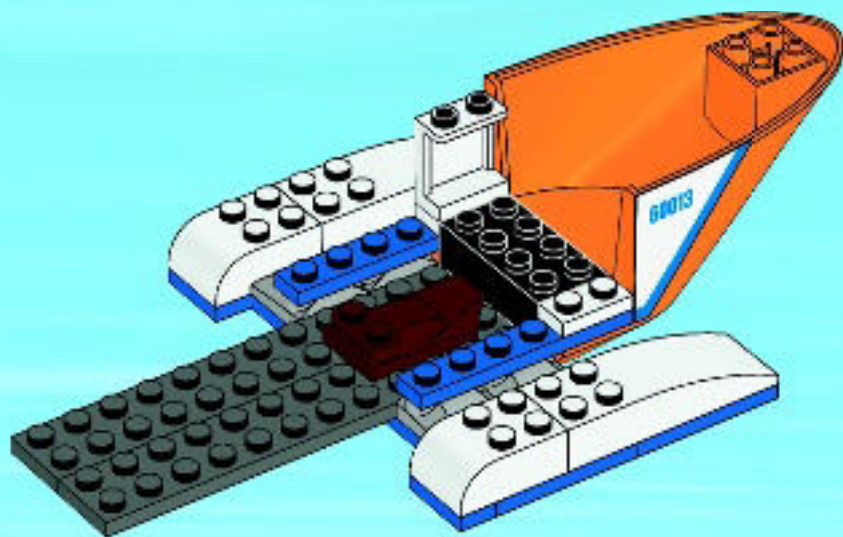



1x

# 10

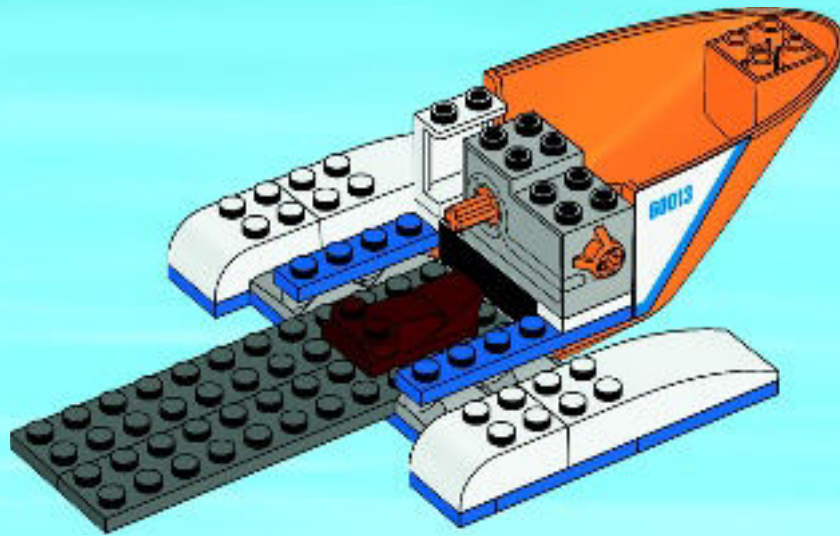



1x



2x

# 11

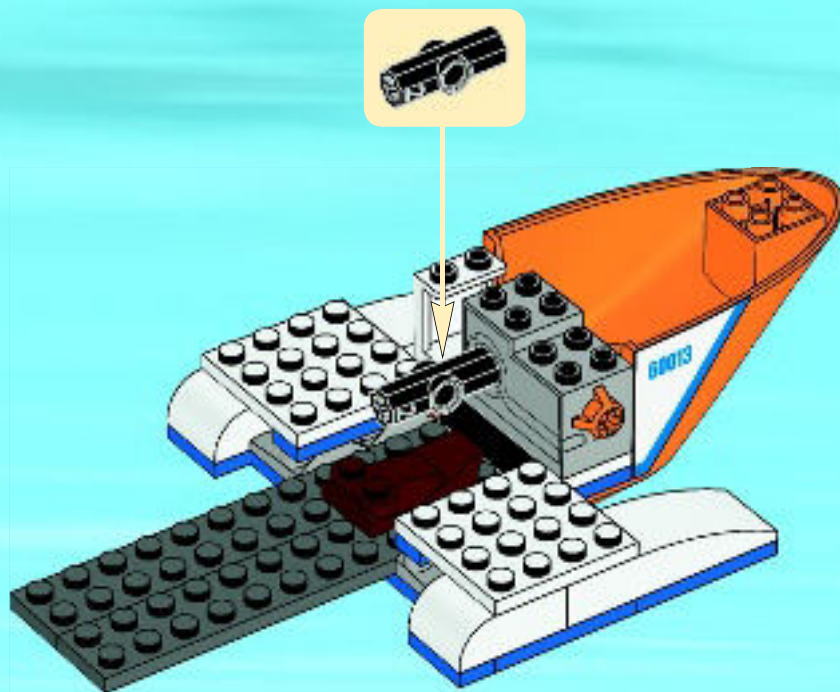



2x



4x

# 12

1

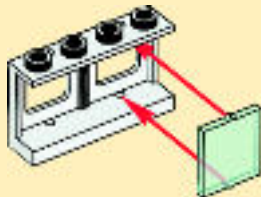

2



2x

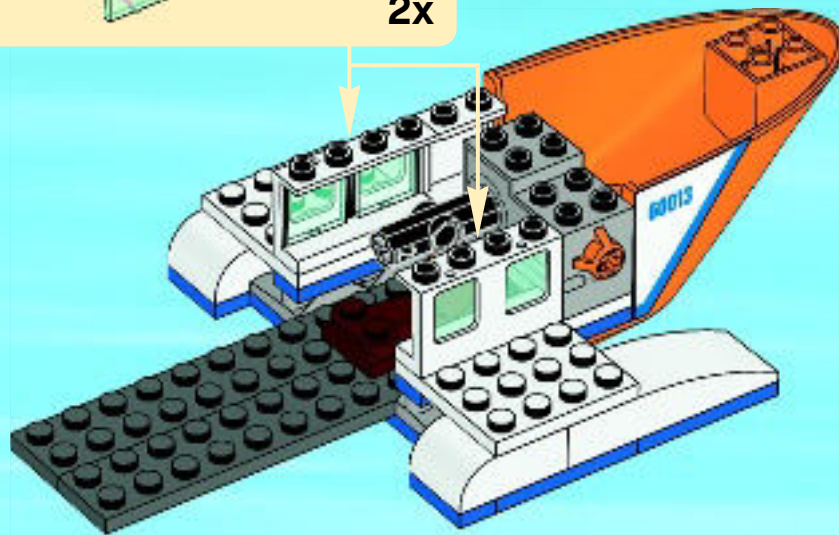



2x

# 13

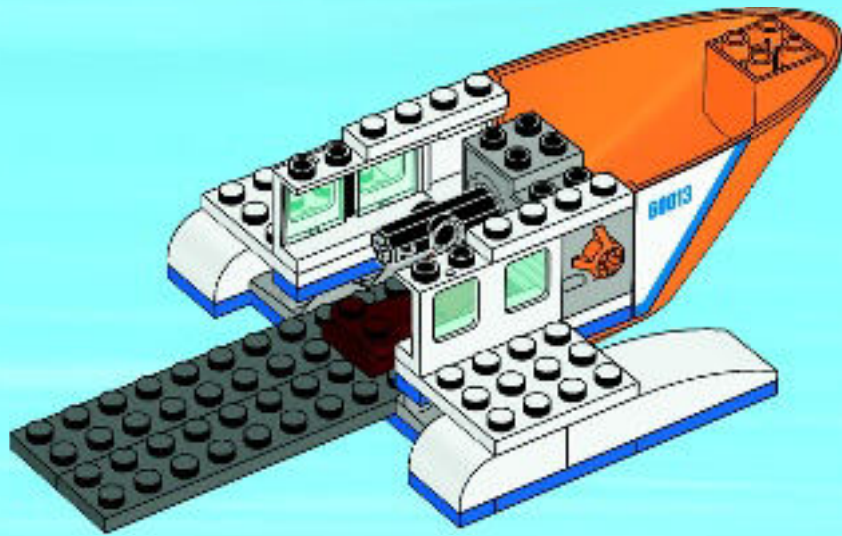



1x



1x



1x



1x

# 14

1

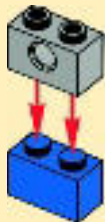

2

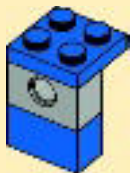

3

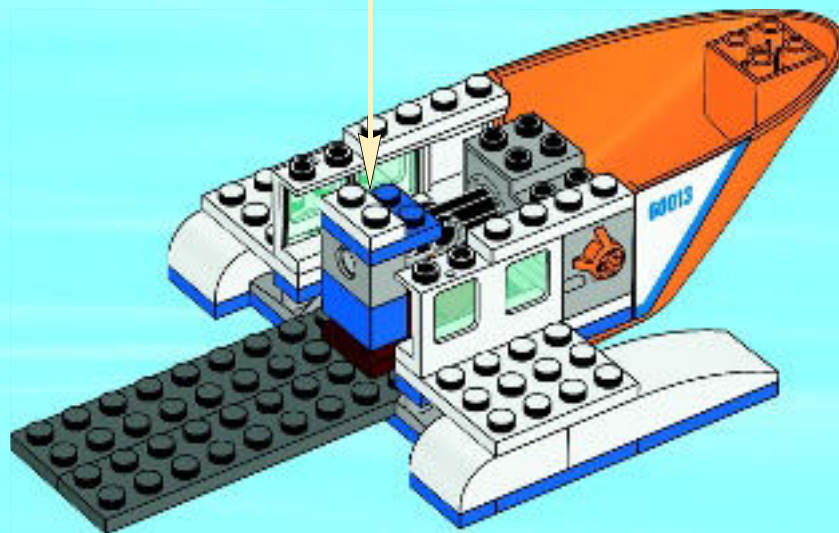





1x

# 15

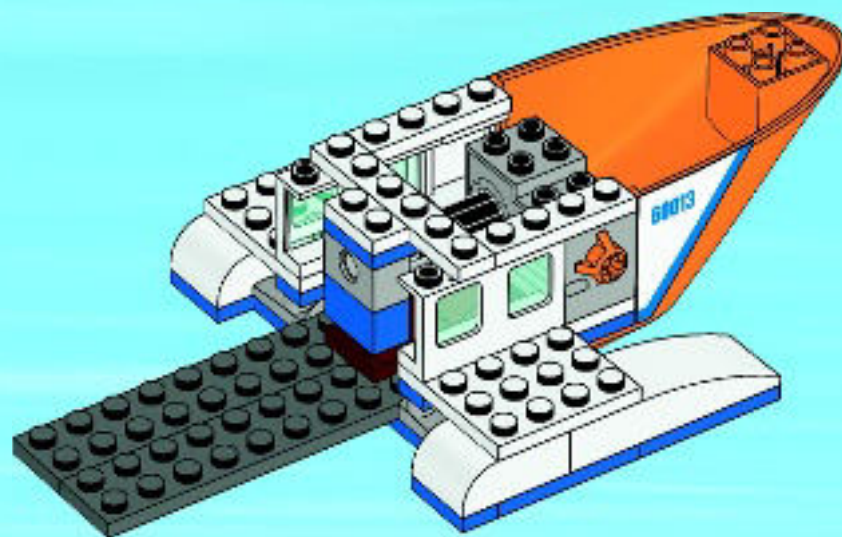

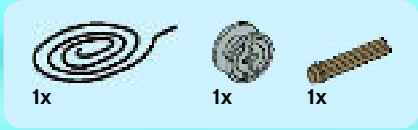

# 16

1

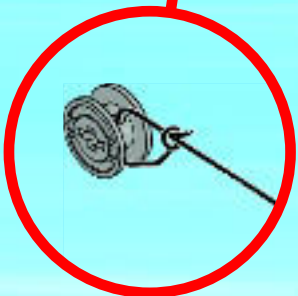

2

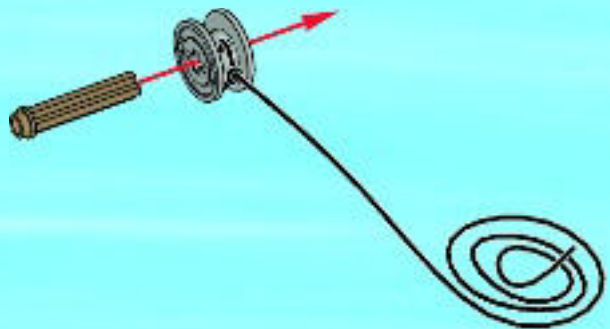

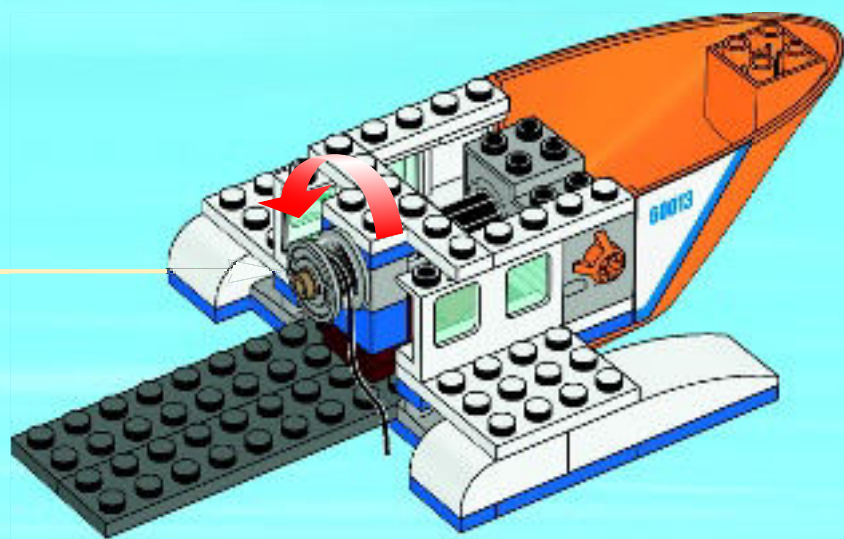

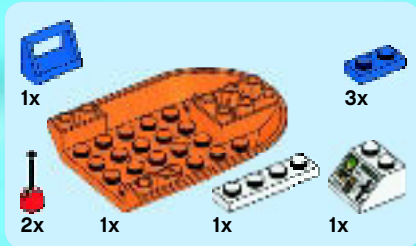

# 17

## 1

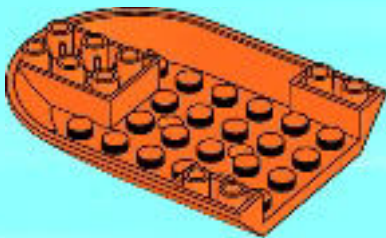

## 2



## 3

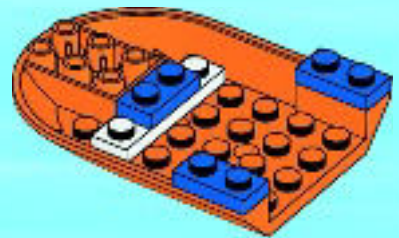

4

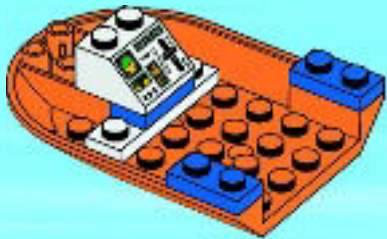

5

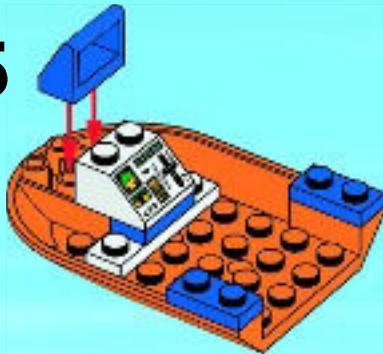

6

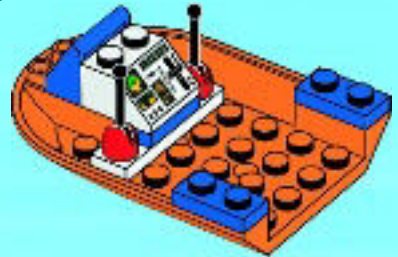

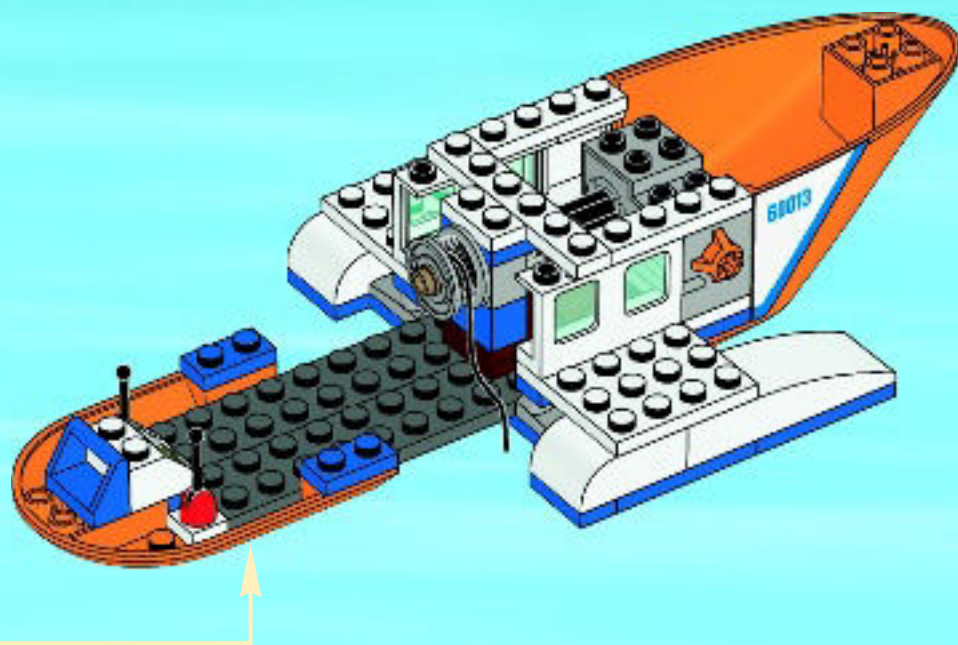





4x

# 18

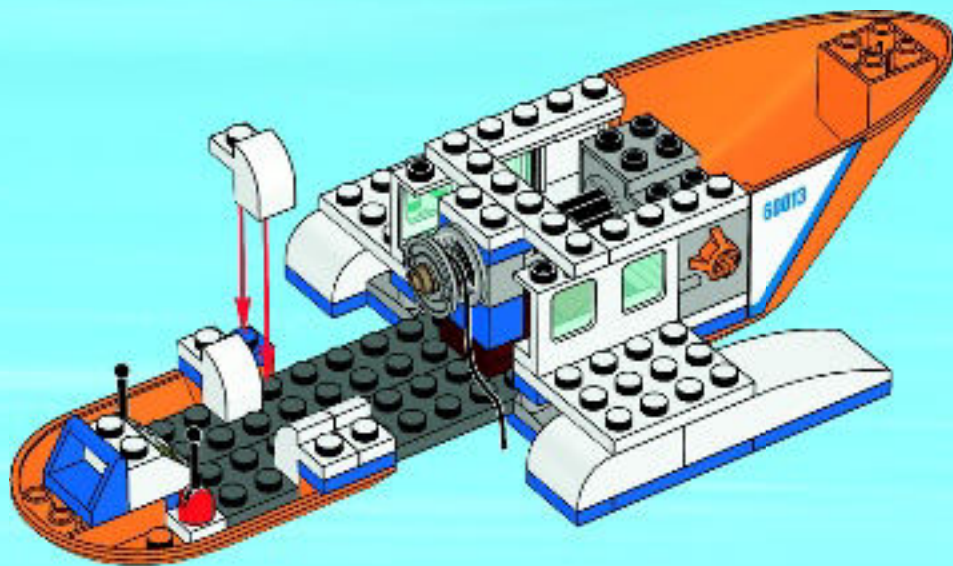



2x

# 19

1



2

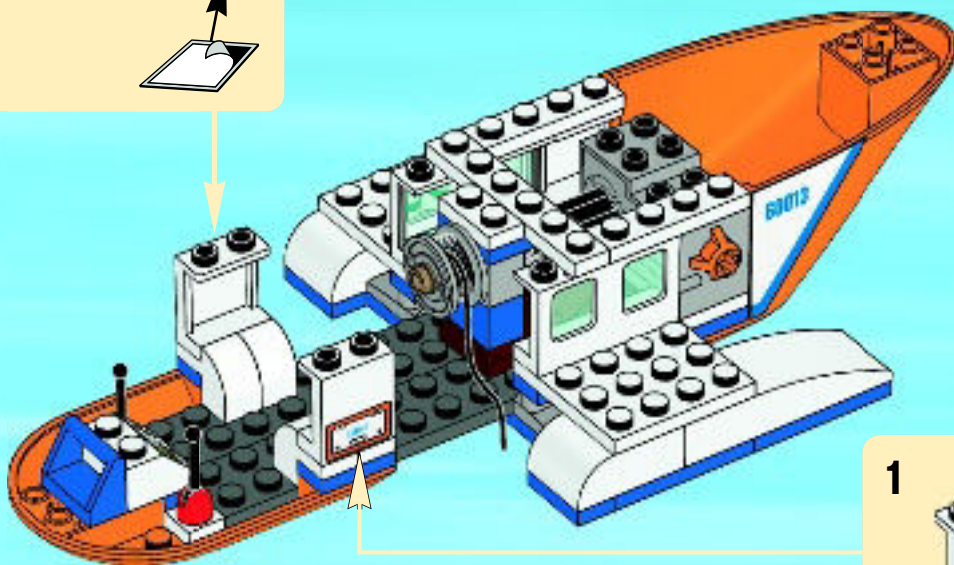

1



2





2x



1x

# 20

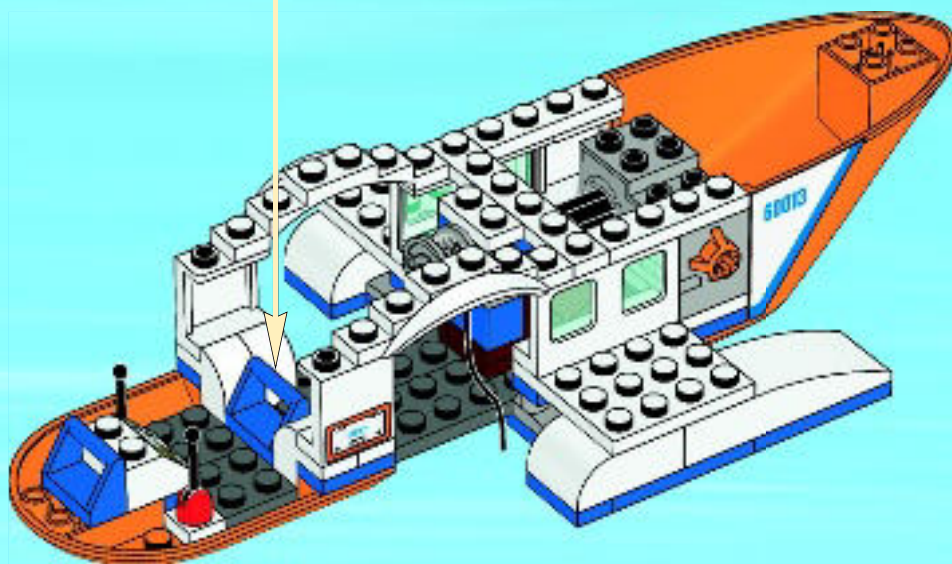



1x



1x



1x

# 21

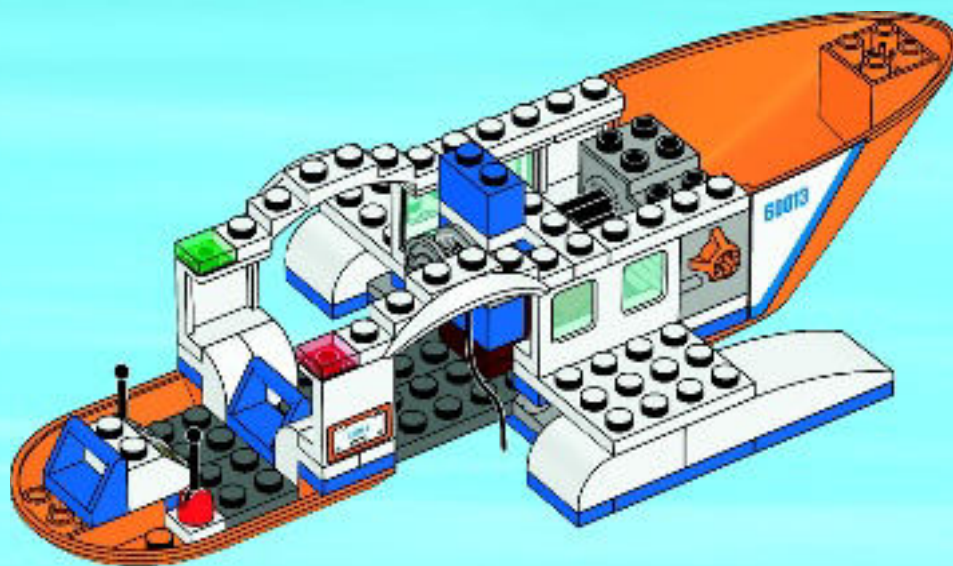

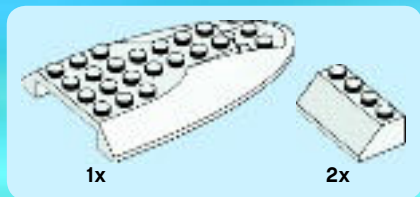

# 22

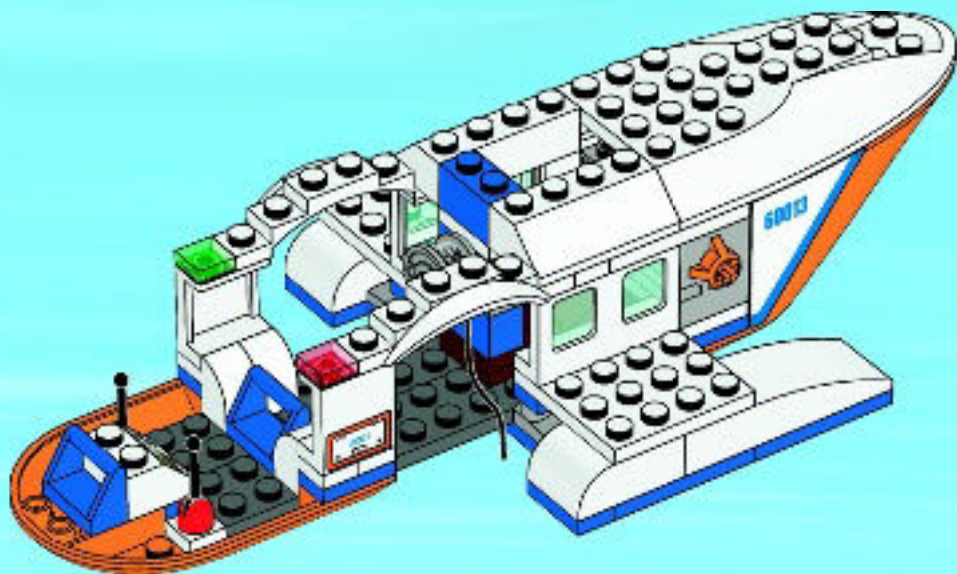



23

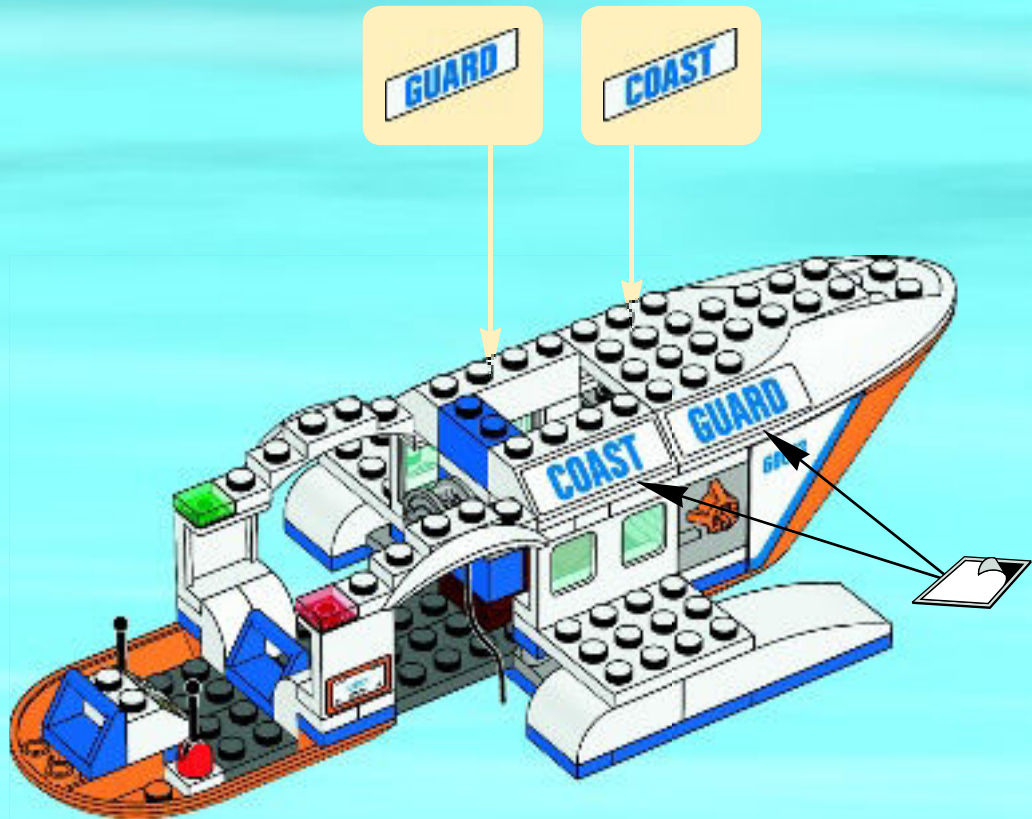



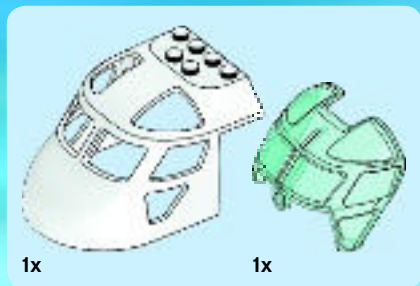

# 24

1

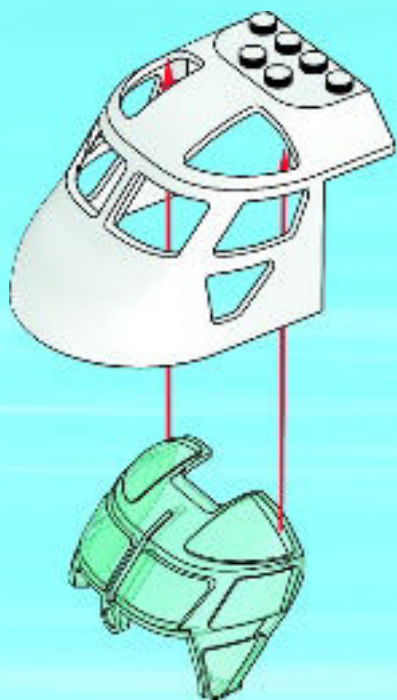

2

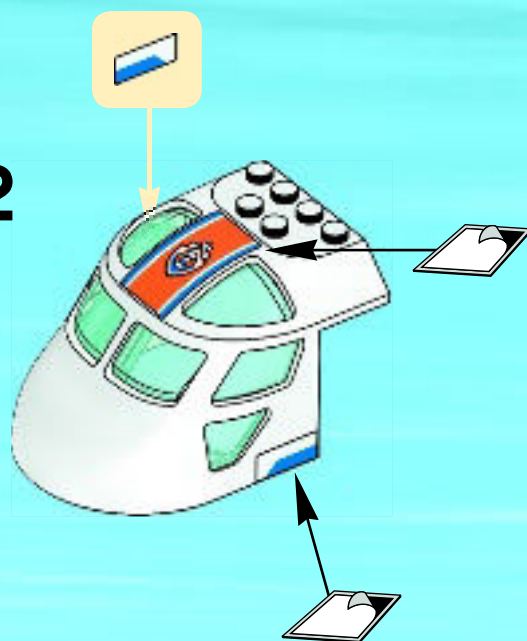

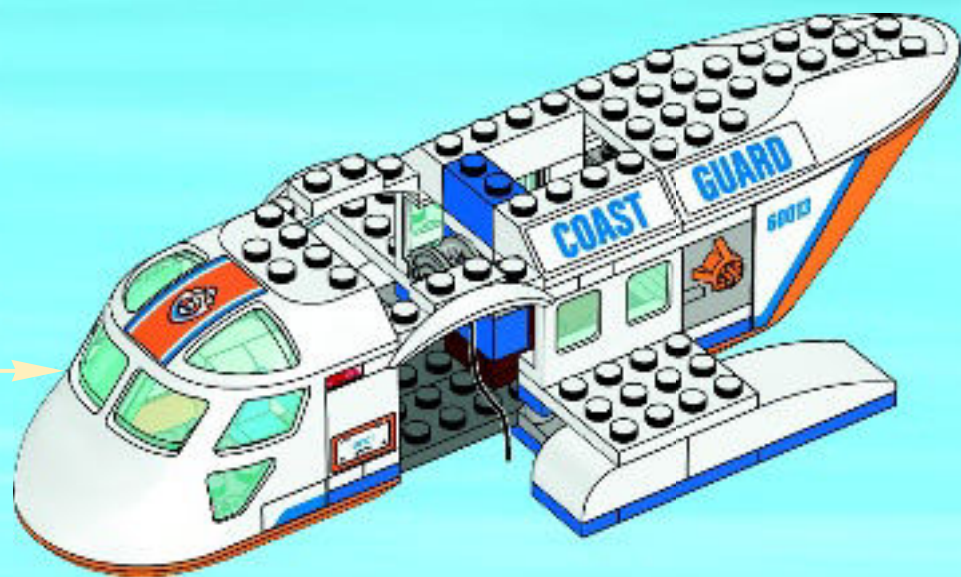



2x

# 25

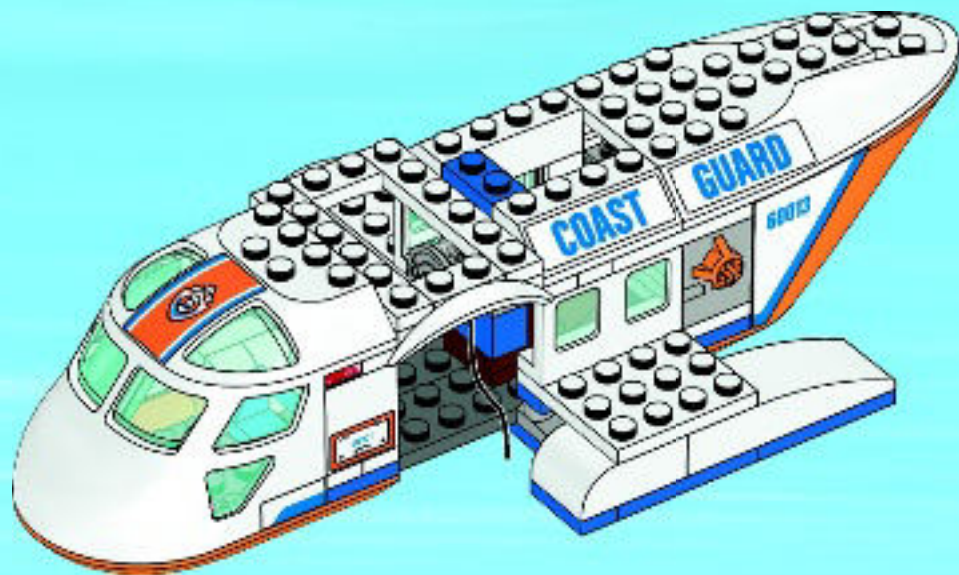



1x

# 26

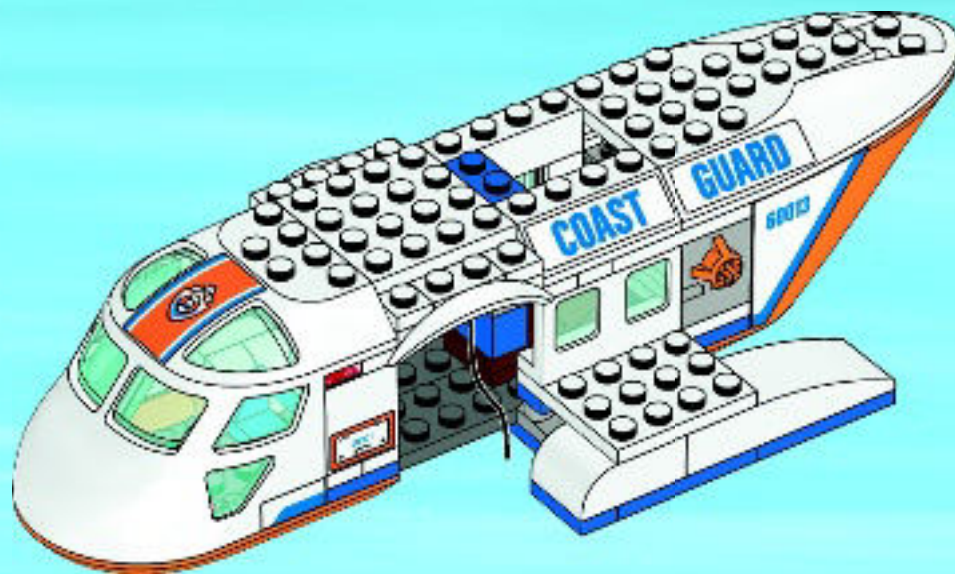



2



1x

27

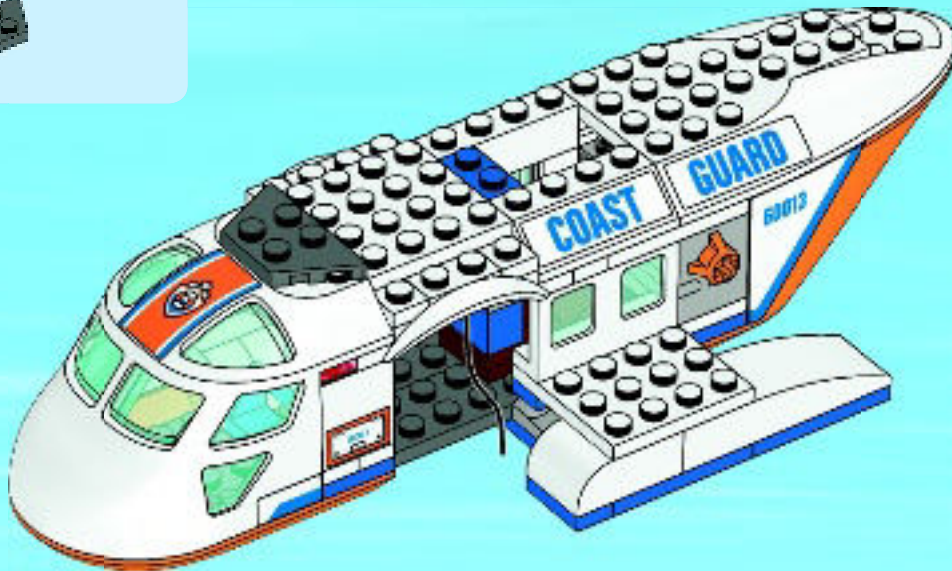





1x



2x

# 28

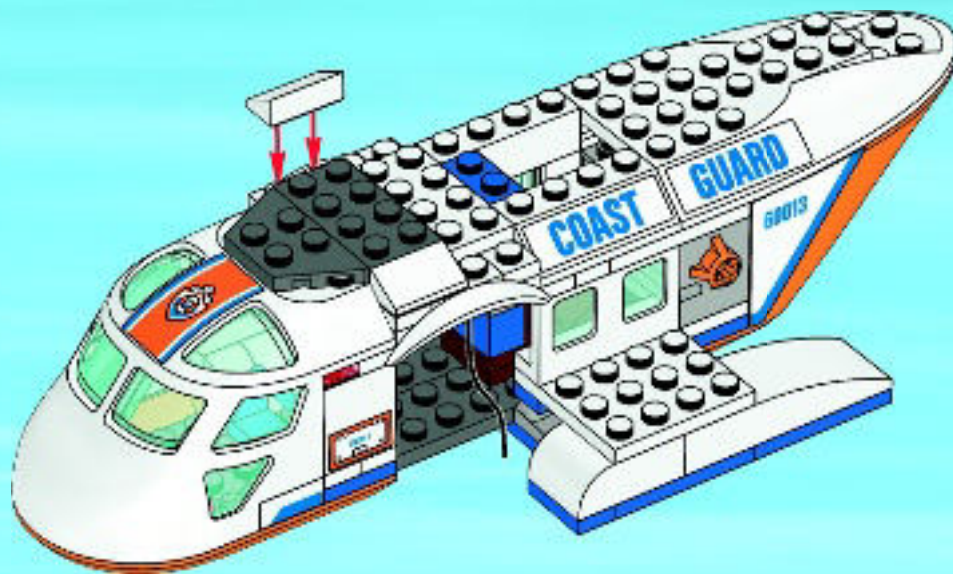





2x

# 29

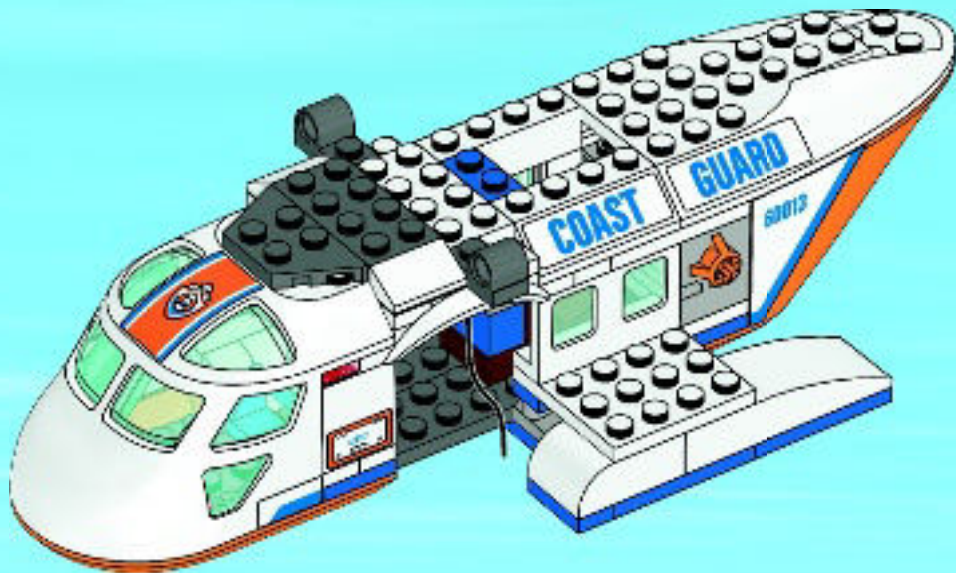



1x



2x

# 30

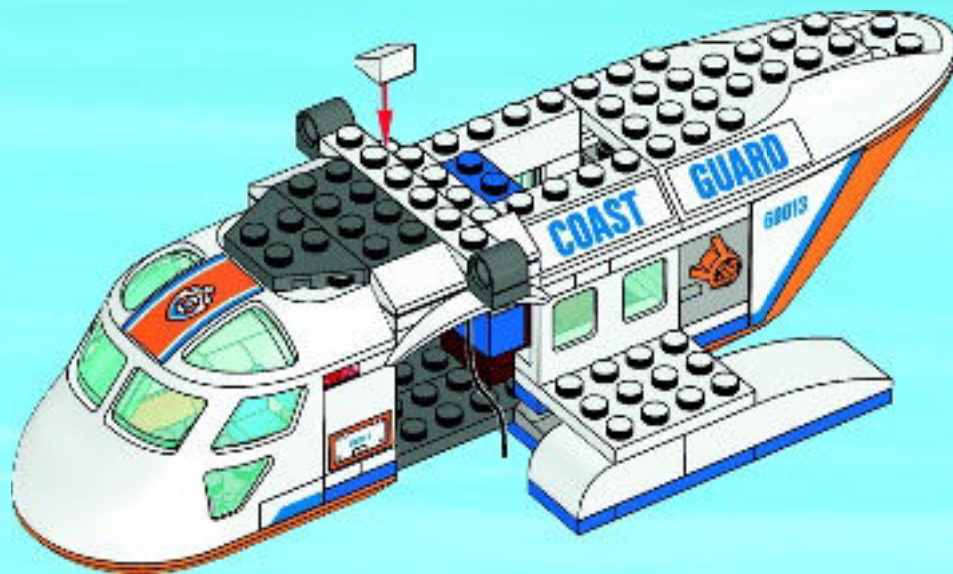



2x

# 31



2x

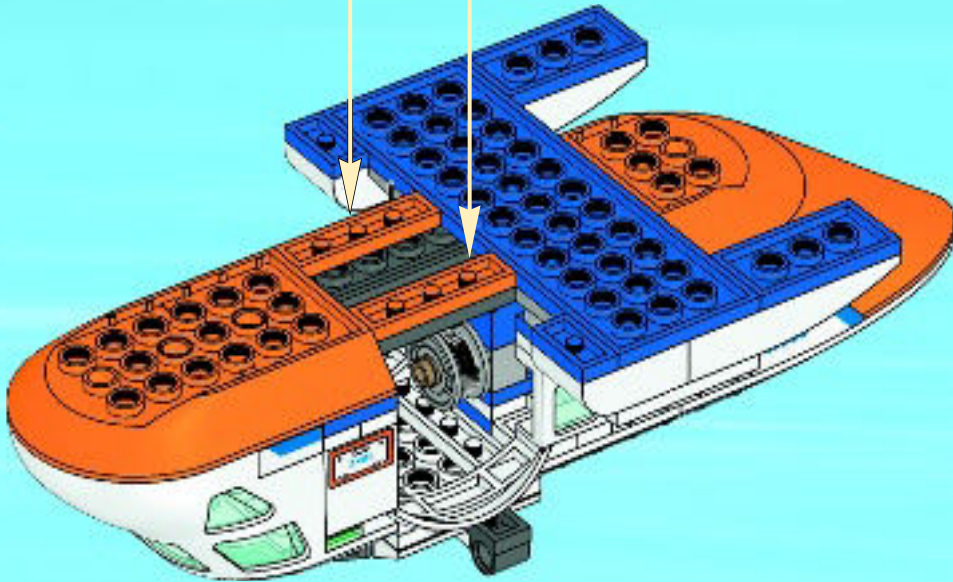

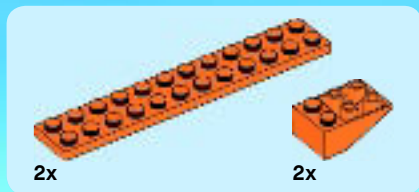

32

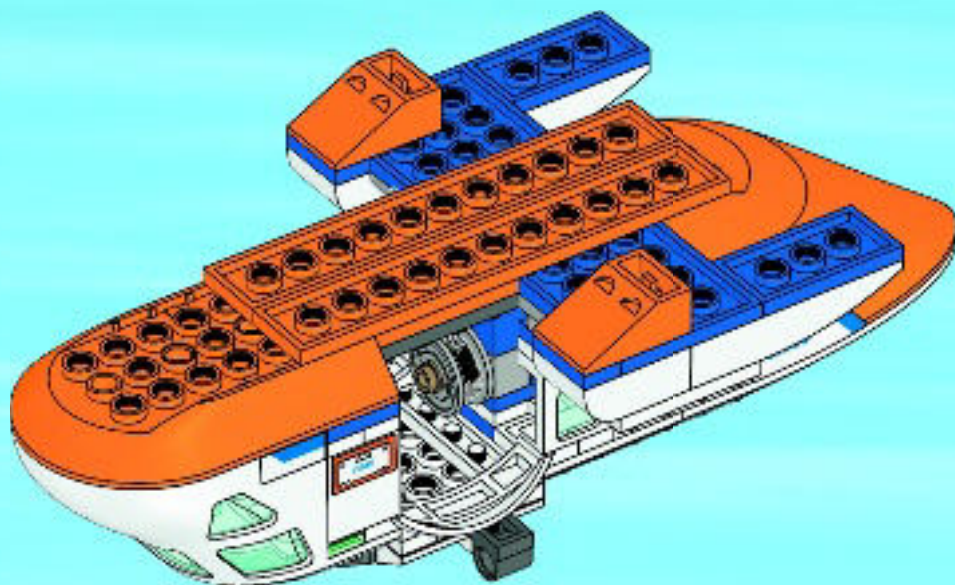



2x



2x

# 33

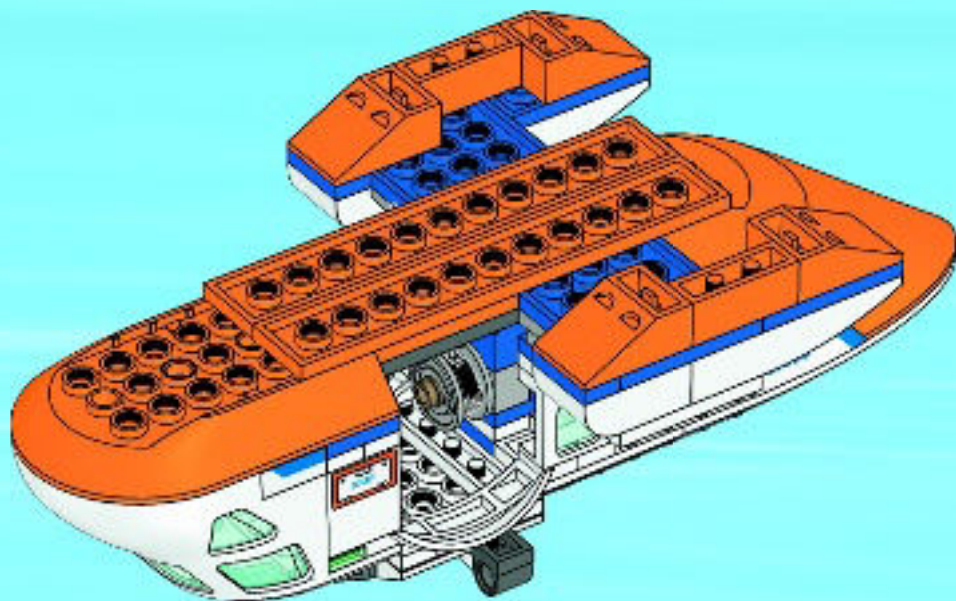





34

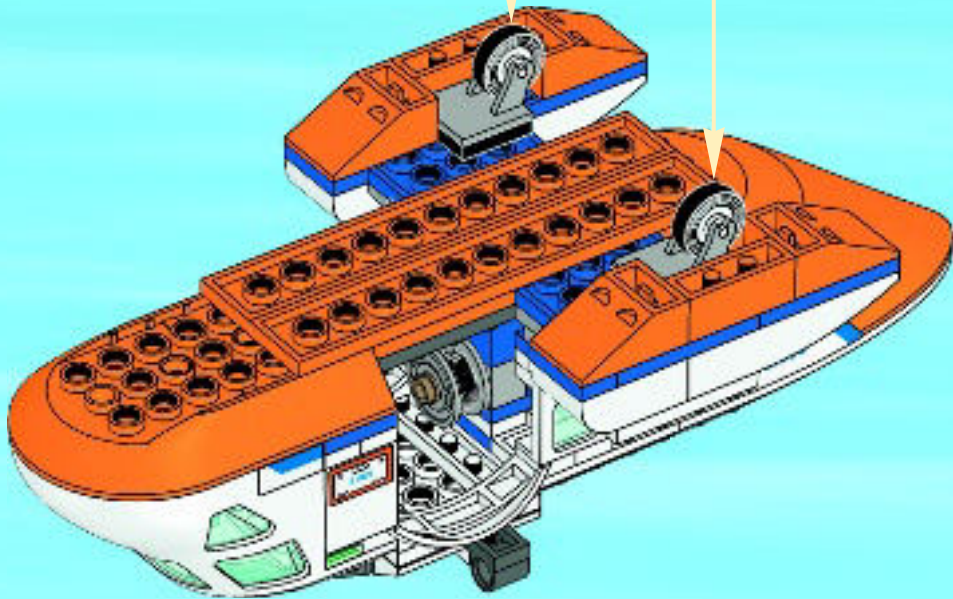
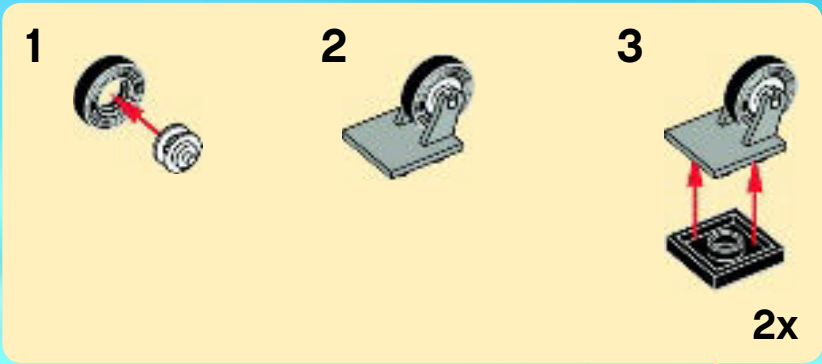





2x



1x



2x



1x

# 35

1



2



3



4

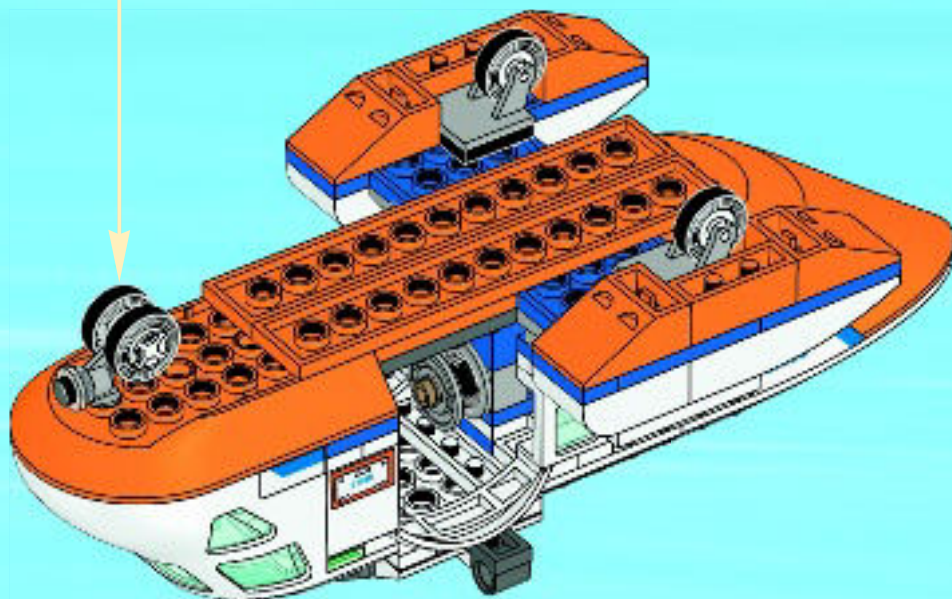



1x

# 36

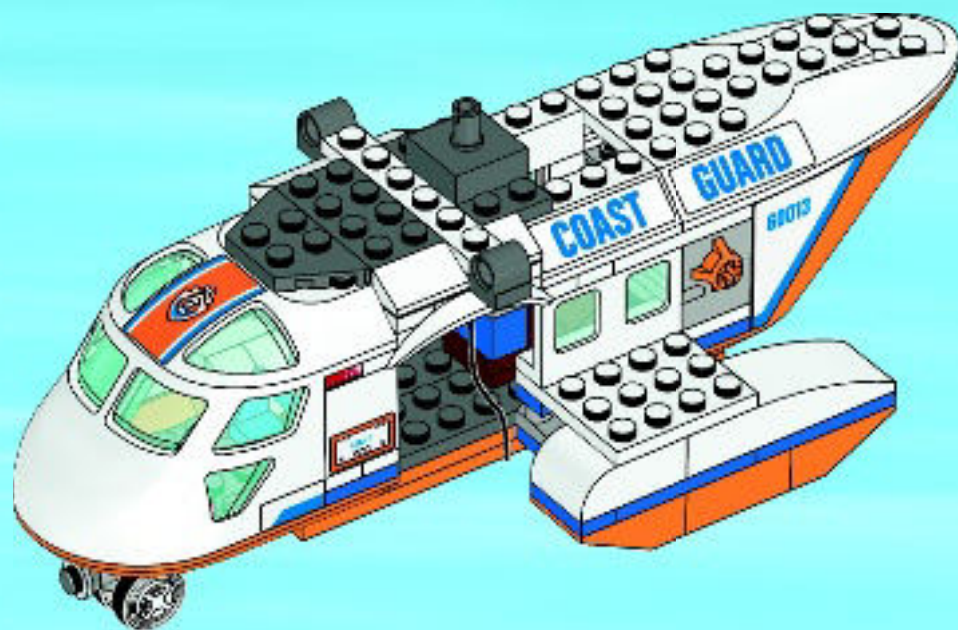



2x

37

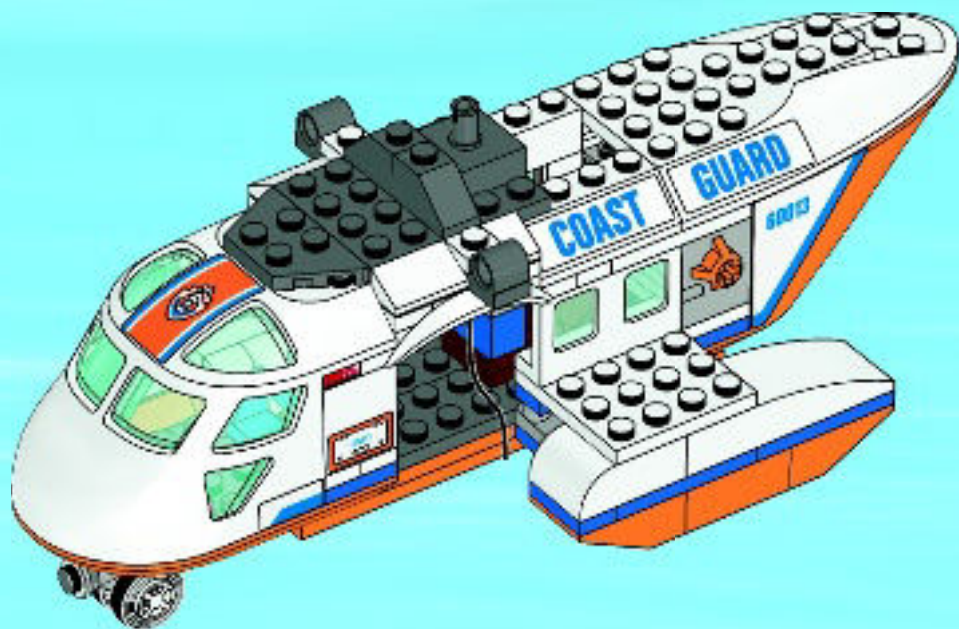



3x

# 38





1x



1x

# 39







1x



1x

# 40

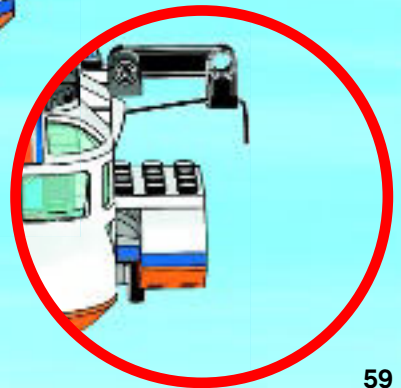
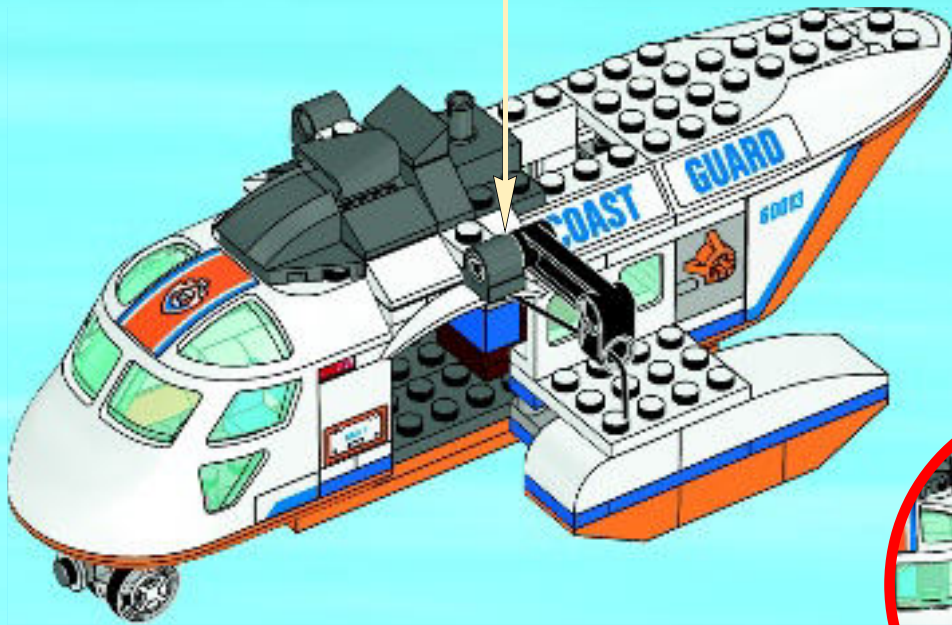
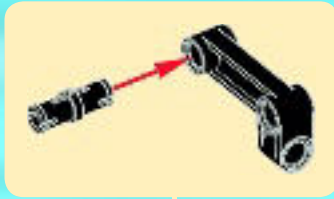





1x

# 41

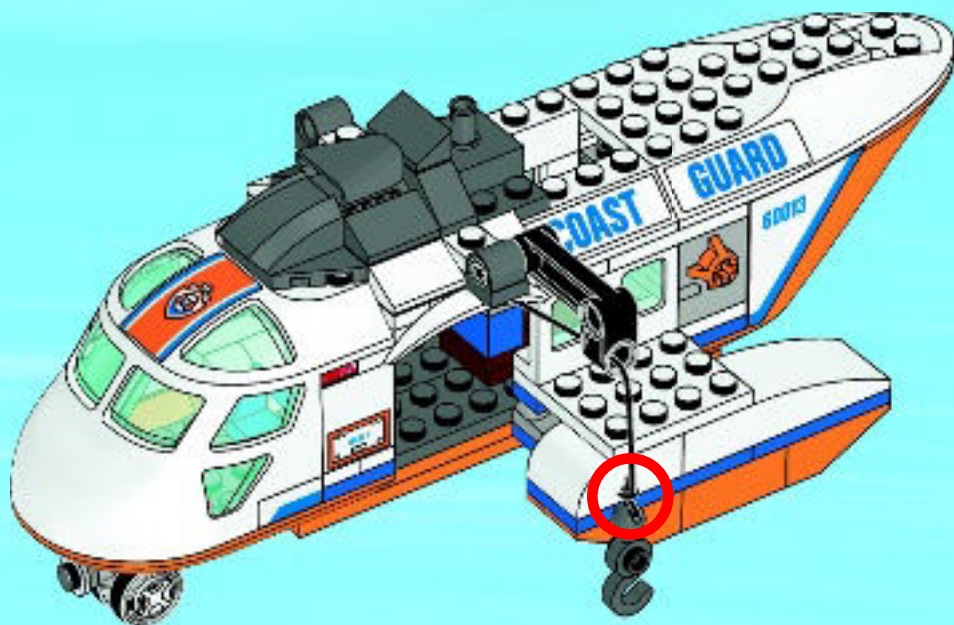

1

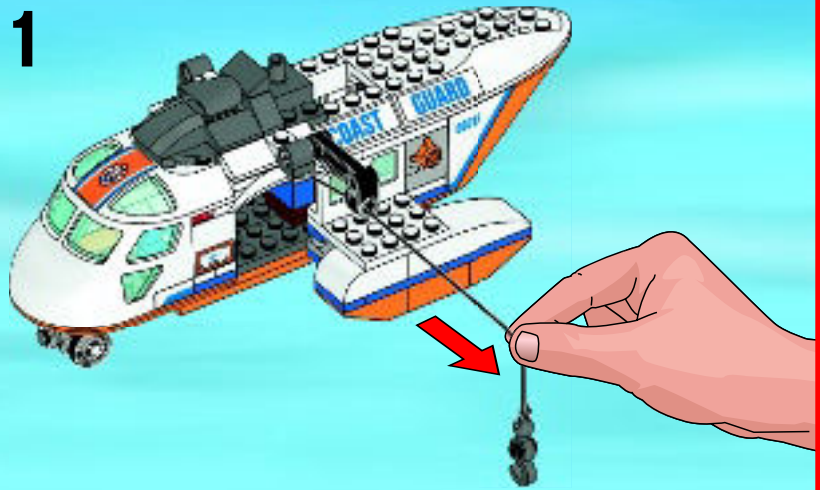

2

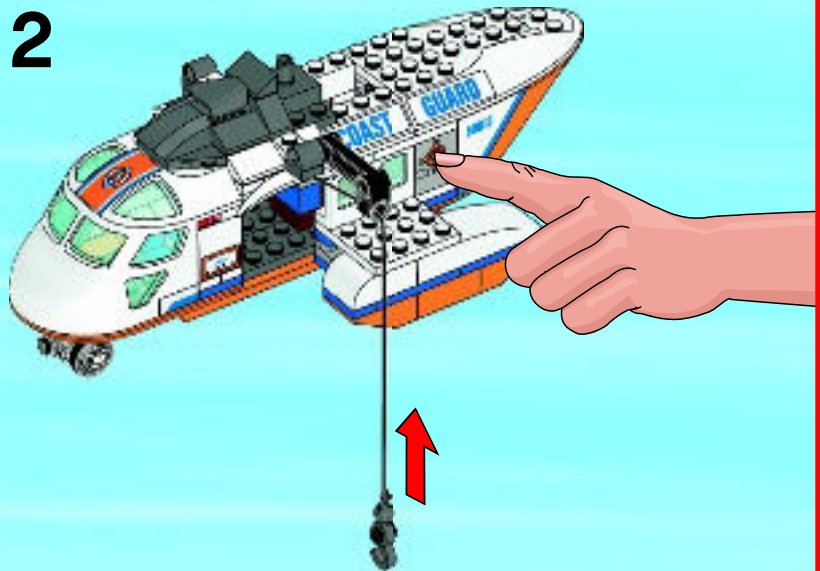



1x



1x

# 42





2x



2x



2x



2x



2x



1x



4x

# 43

1



2



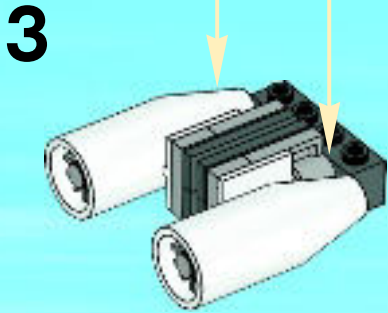
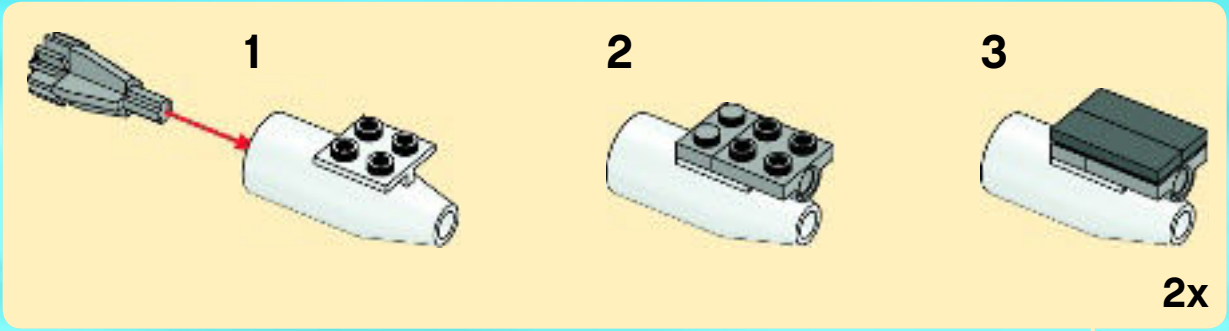

4

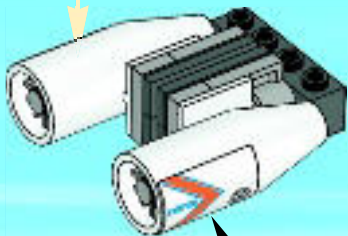



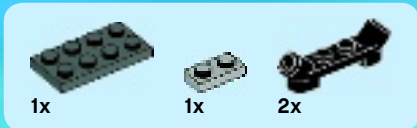

44



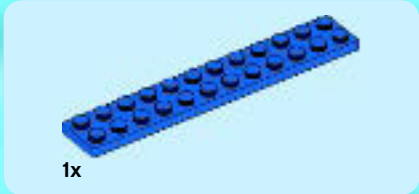

1x

1

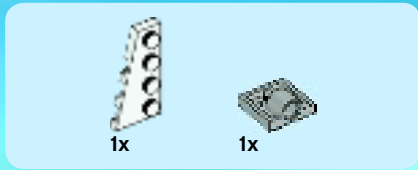
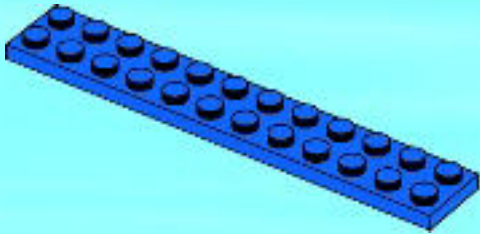

1x

1x

2

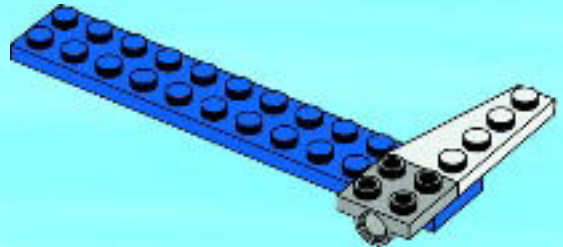



3

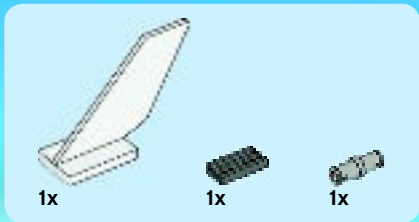
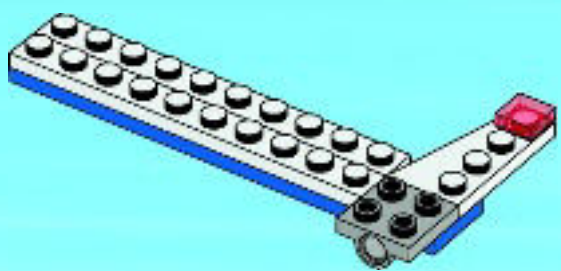

4

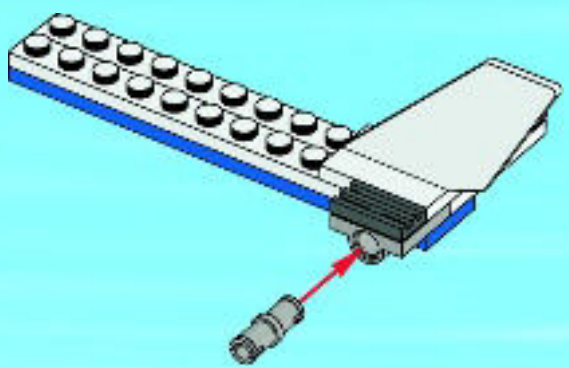

5

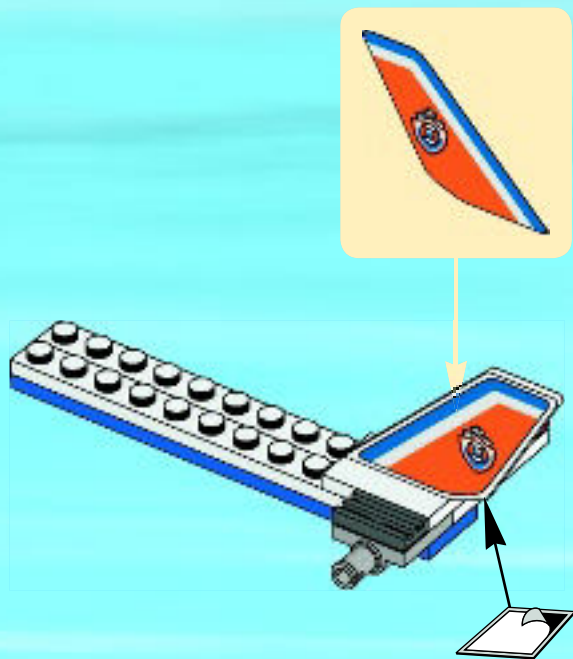

6

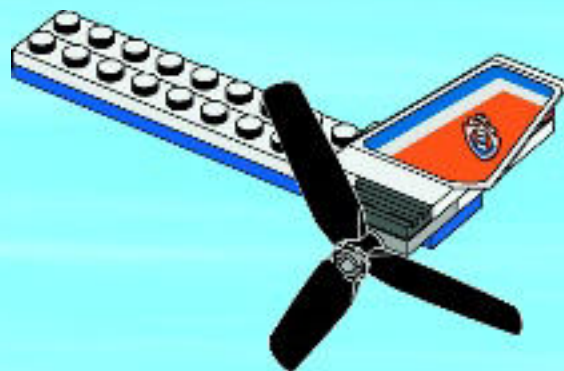

45

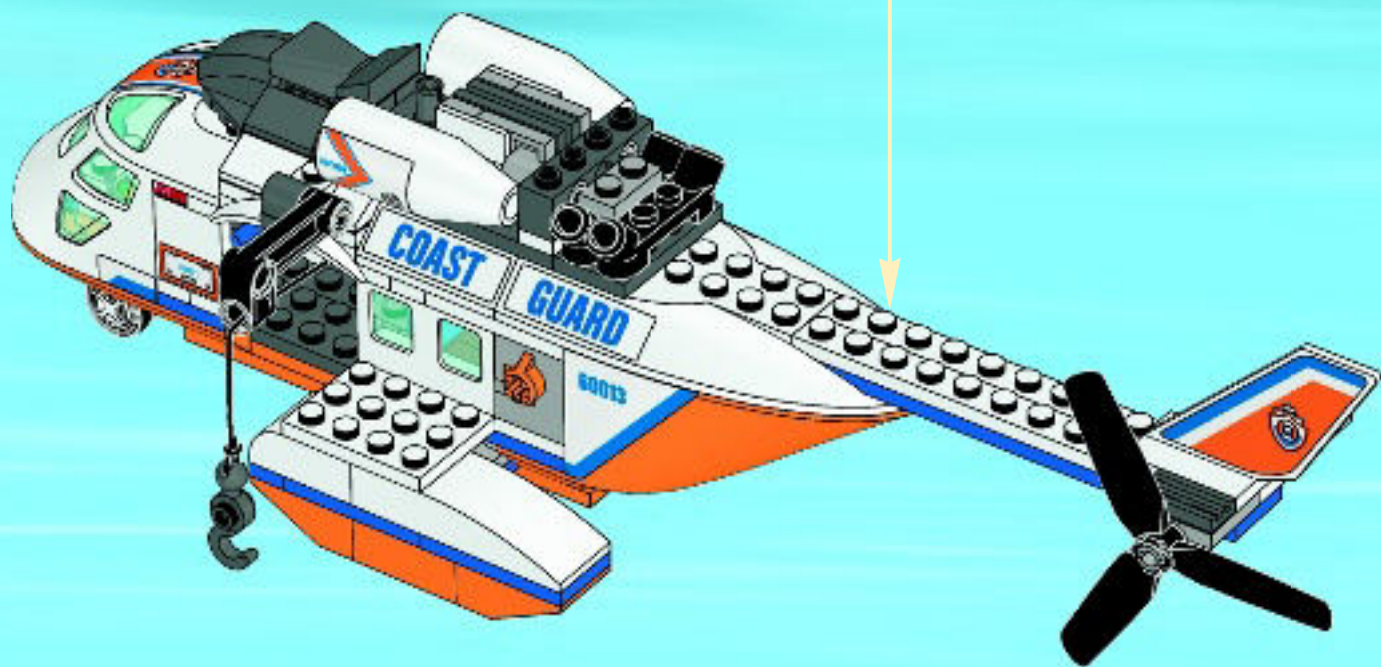





1x

# 46

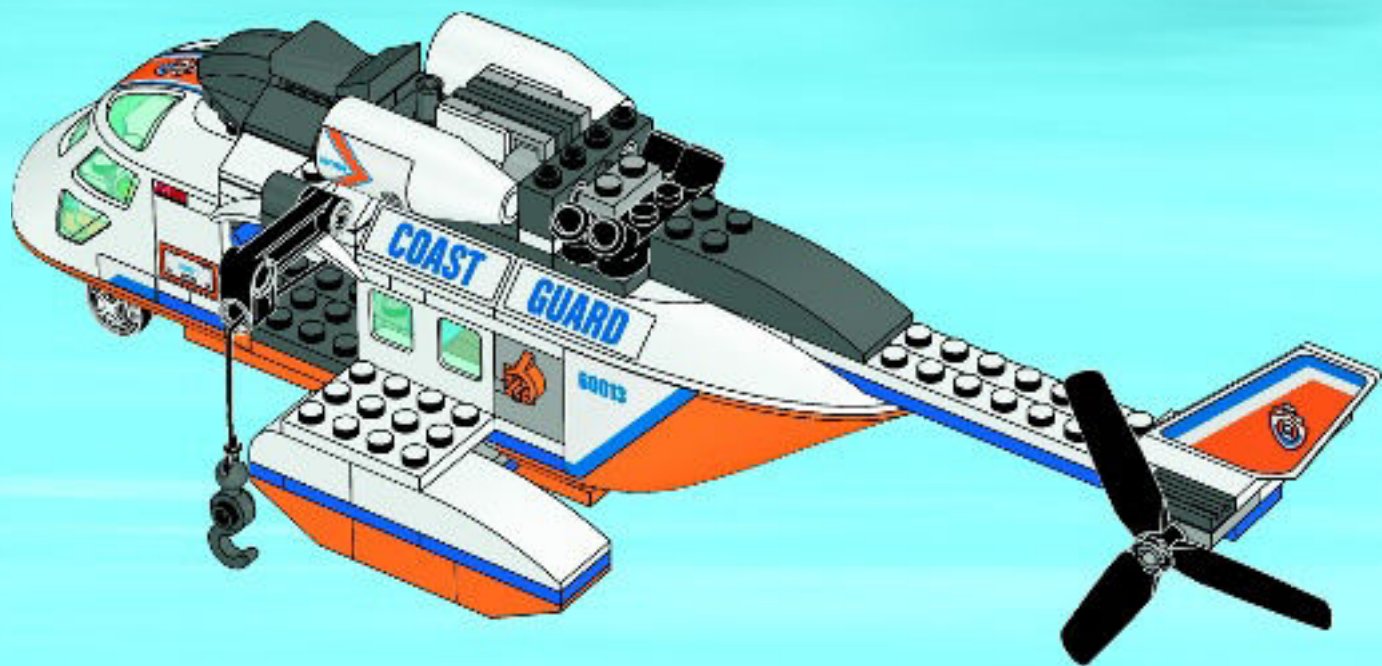





1x



1x

# 47

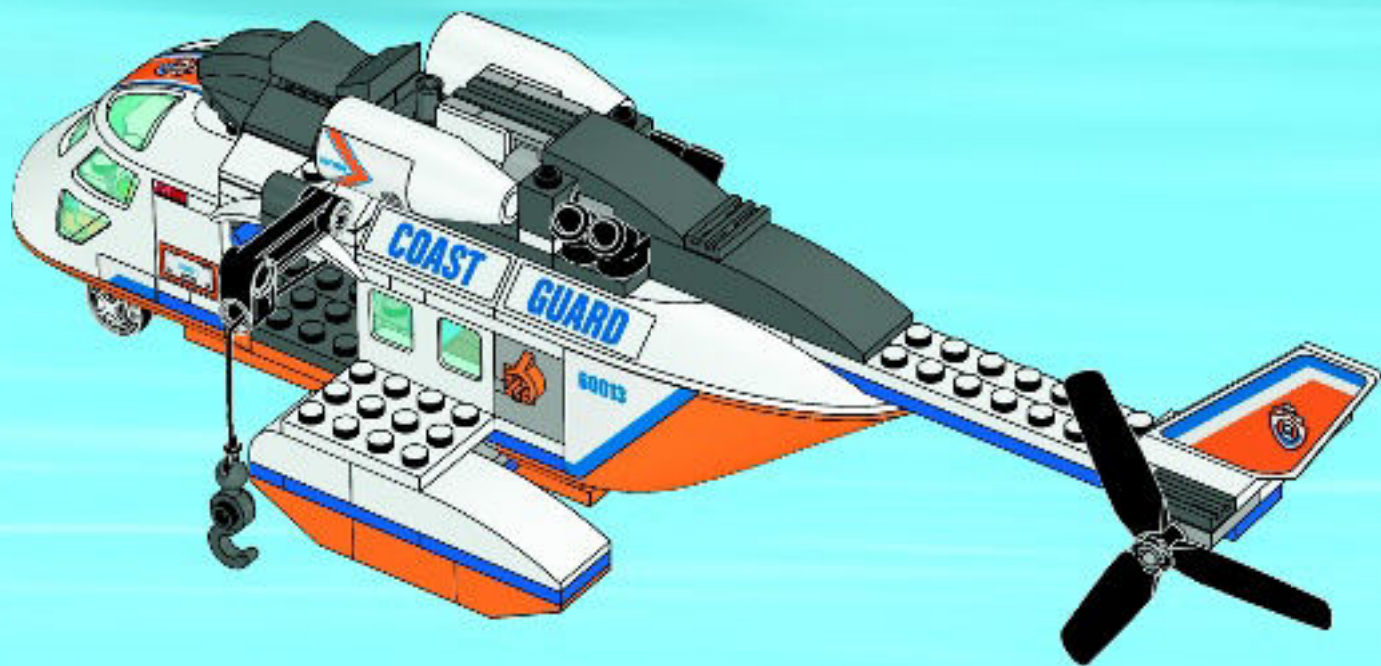



1x



1x

# 48



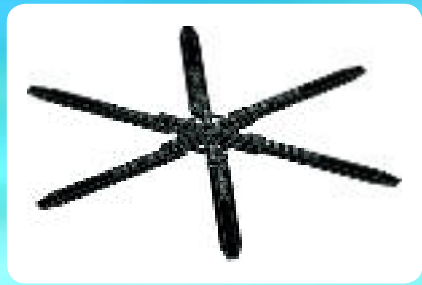

1x

1



6x

2





3

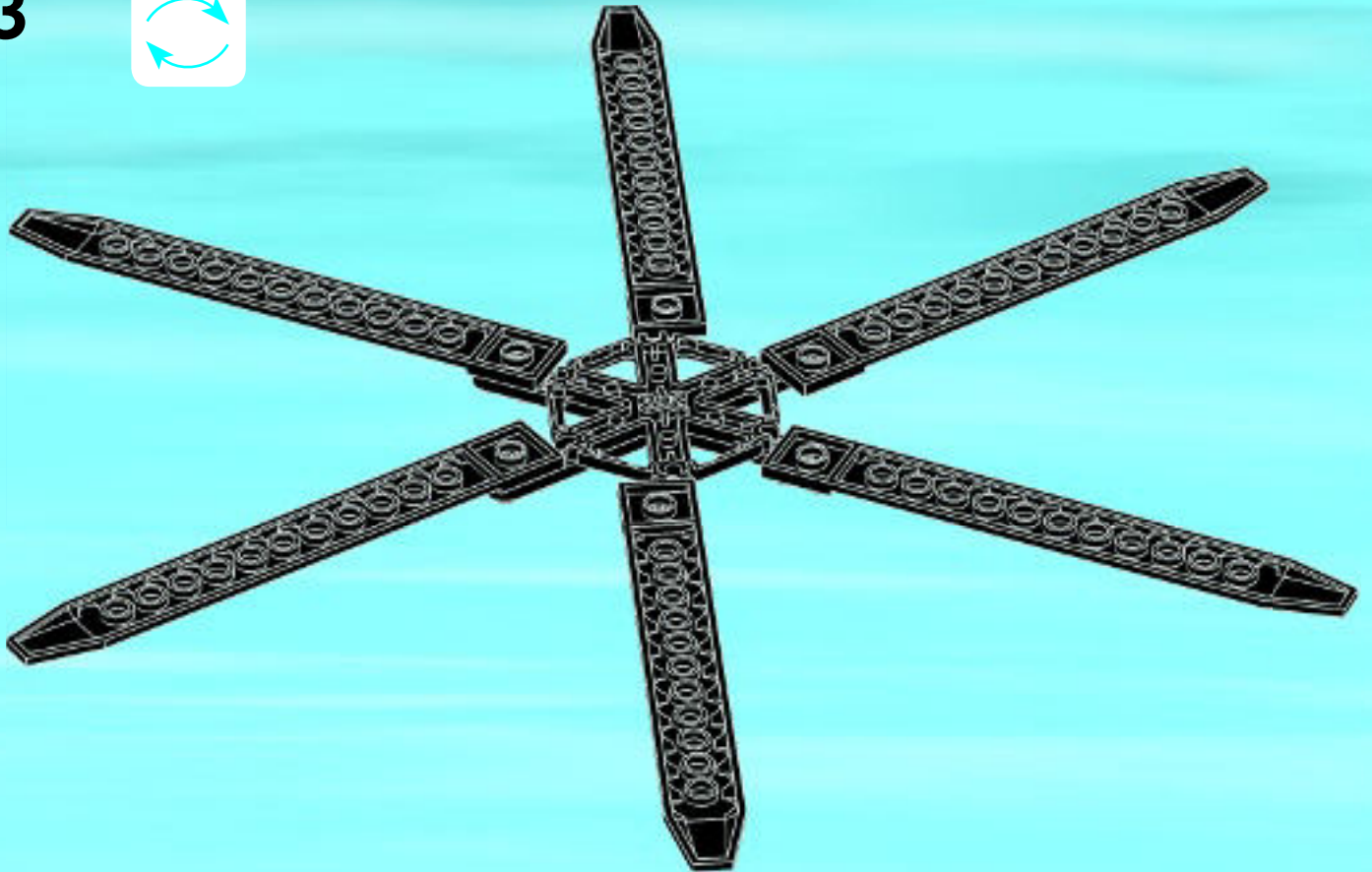



6x

4

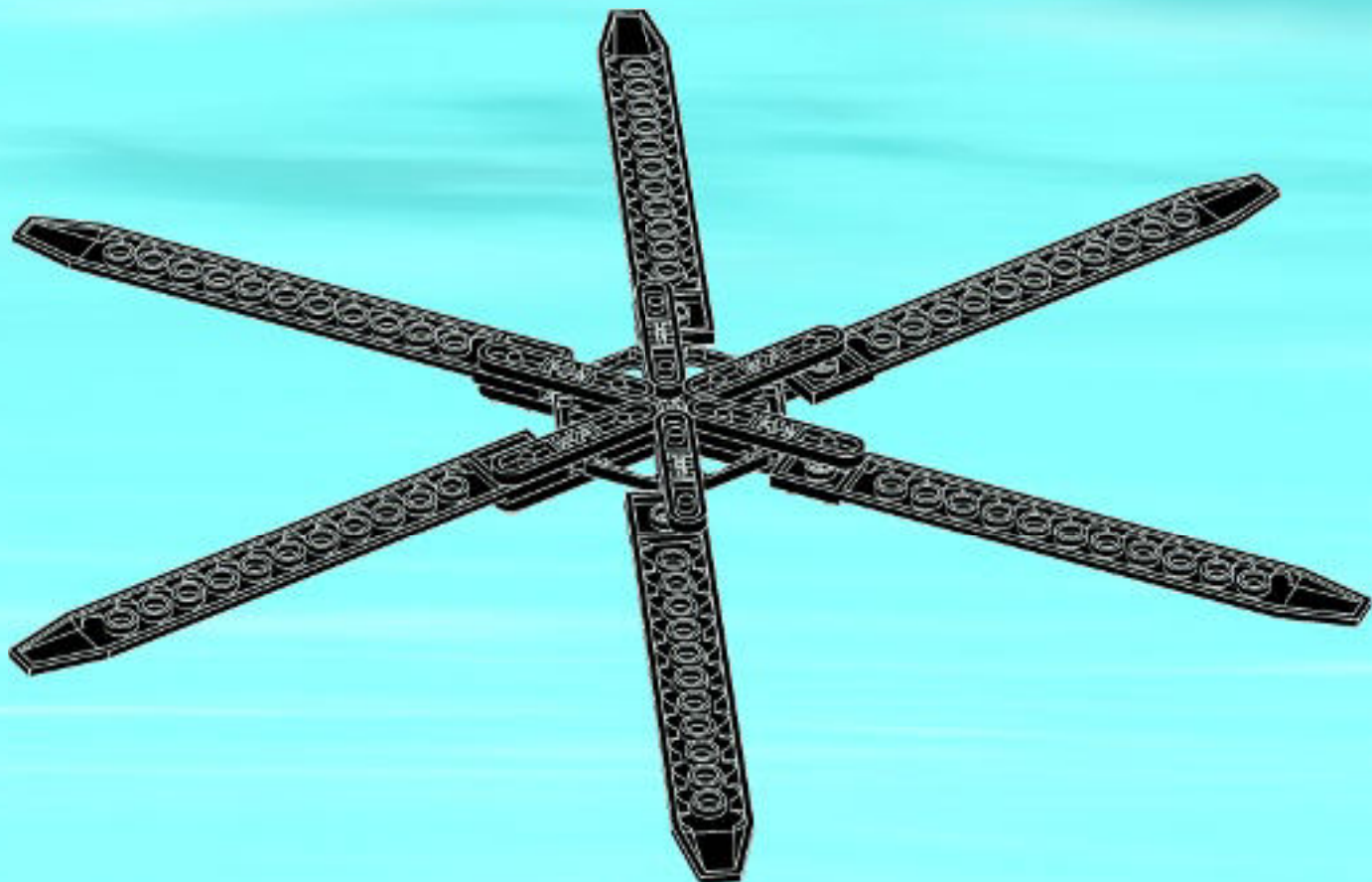



49









CITY



60014



60013



60012



60011



**LEGO** CITY



60004



60003



60002



60001



60000





Nintendo



# CITY

UNDERCOVER



LEGO® City: Undercover software ©2013 TT Games Publishing Ltd. ©2013 The LEGO Group. All rights reserved.

# Wii U™





3x  
4243812



2x  
447701

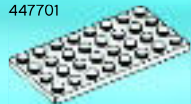

1x  
303501



1x  
6034346



1x  
6034343



2x  
4523556



2x  
4654622



1x  
623901



1x  
6031892



1x  
4560934

82



2x  
462401



2x  
4296997



2x  
4504369



2x  
4547489



1x  
6032098



2x  
303701



4x  
609101



1x  
4624989



2x  
621501



2x  
4160403



2x  
4179870



3x  
302301



4x  
371001



8x  
366601



1x  
4161326



3x  
4585458



2x  
4521846



2x  
4298609



2x  
4520782



3x  
379421



2x  
366621



2x  
307021



1x  
243121



2x  
74335



2x  
6040342



1x  
6031821



1x  
4507833



1x  
4609907



1x  
4535553



2x  
243223



1x  
9341



1x  
6032176



1x  
4206482



2x  
300423



5x  
302323



1x  
302223



2x  
302023



2x  
366623



1x  
244523



1x  
4528850



1x  
6036006



1x  
9339



1x  
6032681



1x  
4184617



1x  
4142731



1x  
300126



2x  
302226



12x  
4114689



1x  
4539442



1x  
4538722



1x  
4648298



6x  
4527604

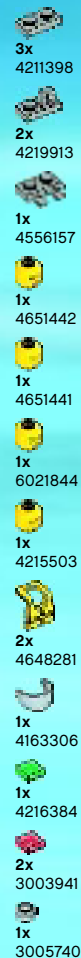
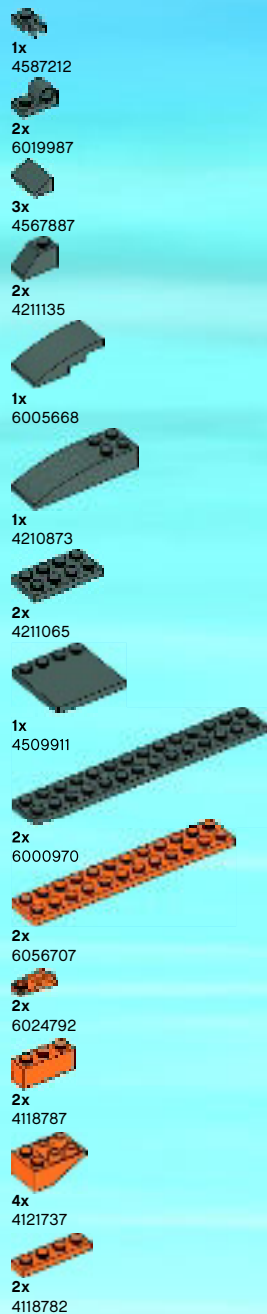

**Customer Service**  
**Kundenservice**  
**Service Consommateurs**  
**Servicio Al Consumidor**

**LEGO.com/service or dial**



**: 00800 5346 5555**

**: 1-800-422-5346**



# WIN!

Go to [www.LEGOsurvey.com/product](http://www.LEGOsurvey.com/product) to fill out a survey for a chance to win a cool LEGO® Product. No purchase necessary. Open to all residents where not prohibited.



LEGO.com



## [www.LEGOsurvey.com/product](http://www.LEGOsurvey.com/product)

### GEWINNE! WIN!

Nimm an der Umfrage auf [www.LEGOsurvey.com/product](http://www.LEGOsurvey.com/product) teil und hab die Chance ein cooles LEGO® Produkt zu gewinnen!

Die Teilnahme am Gewinnspiel führt zu keinerlei Kaufverpflichtungen. Teilnahme in allen nicht ausgeschlossenen Ländern möglich.

Ga naar [www.LEGOsurvey.com/product](http://www.LEGOsurvey.com/product), vul een enquêteformulier in en maak kans op een cool LEGO® product.

Geen aankoopverplichting. Iedereen mag deelnemen, uitgezonderd ingezetenden van landen waar een enquêteverbod geldt.

### GAGNE! 当てよう!

Visite [www.LEGOsurvey.com/product](http://www.LEGOsurvey.com/product) pour répondre à un questionnaire et avoir une chance de gagner un produit LEGO® très cool!

Aucune obligation d'achat. Ouvert à tous les résidents des pays autorisés.

[www.LEGOsurvey.com/product](http://www.LEGOsurvey.com/product) にアクセスして、アンケートにご記入ください。当選者にはレゴ®製品を差し上げます。

お買い上げの必要はありません

禁止されていない限り、すべての皆様にご利用いただけます。